

contract

MIDJ<sup>®</sup>

in Italy



Company.....	pag. 10
Sedie - Chairs .....	pag. 18
Tavoli - Tables .....	pag. 242
Accessori - Accessory .....	pag. 306
Espositori - Display.....	pag. 311
Finiture - Finishes .....	pag. 316

# Sedie Chairs



Nenè p. 20



Liù p. 36



Raff p. 46



Twist p. 52



Jade p. 60



Joe p. 66



Sonny p. 70



Matrix p. 76



Marilyn p. 80



Cover p. 86



Krono p. 100



Zelig p. 104



Trampoliere p. 108



Italia p. 116



Light p. 120



Madame p. 124



Revolution p. 126



Imola p. 128



Prinz p. 128



Stone p. 130



Passepartout p. 132



Giudecca p. 136



City p. 138



Nuda p. 140



Miss p. 142



Flina p. 144



Flona p. 144



Silvy TS p. 146



Silvy CU p. 152



Soffio p. 156



King p. 160



Sharon p. 162



Elettra p. 166



Guapa p. 168



Apelle p. 176



Ciak p. 186



F12 p. 188



Portofino p. 192



Www p. 196



Axial p. 198



Marsiglia p. 200



Island p. 204



Vivo p. 206



H5 p. 210



Istar p. 216



Bongo p. 218



John p. 220



Mark p. 222



Kayak p. 224



Zow p. 226



Happy Kreer p. 228



Afra p. 230



Billy p. 232



Kasha p. 234



Relax p. 236



T.T. Relax p. 238



Mask p. 240

Tavoli  
Tables



Armando p. 244



Toronto p. 250



Portofino p. 256



london p. 260



Drive p. 262



Brioso p. 264



Poker p. 268

Basamento centrale  
Bistrot table



Sintesy p. 270



Four p. 272



Trampoliere p. 274



Italia p. 276



Break p. 278



Infinity p. 280



Face p. 284



Composit p. 286



Smart p. 290

## Coffee tables



Dj p. 294



Walter p. 296



Guapa p. 298



Apelle CT p. 300



Joint p. 302



Trip p. 304

# Sedie Chairs

pag.	Materiale - Material					Esterno Outdoor	Tipologia - Type					
	Plastica Plastic	Metallo Metal	Cuoio Hide	Tessuto Fabric	Legno Wood		Sedia Chair	Poltrona Armchair	Sgabello Stool	Dattilo Office chairs	Attesa Visitor's chair	
Nenè	20	•		•	•	•	•	•				
Liù	36	•	•		•	•	•	•			•	
Raff	46	•	•		•	•	•		•		•	•
Twist	52	•	•		•	•	•			•	•	•
Jade	60		•			•		•	•	•		•
Joe	66		•	•	•	•		•				
Sonny	70		•		•	•		•	•	•		
Matrix	76				•	•		•	•	•		
Marilyn	80		•		•			•	•			
Cover	86		•		•	•		•	•	•		•
Krono	100		•		•			•				
Zelig	104	•	•		•	•		•	•		•	
Trampoliere	108		•		•			•	•	•		
Italia	116		•		•			•	•	•	•	
Light	120		•		•			•	•	•		•
Madame	124		•		•				•			
Revolution	126		•		•			•		•		
Imola	128		•	•				•				
Prinz	128		•		•			•		•		
Stone	130		•		•			•	•	•		
Passepartout	132	•	•	•	•	•	•	•				
Giudecca	136					•		•		•		
City	138	•	•					•				
Nuda	140		•					•		•		
Miss	142		•	•				•				
Flina	144		•	•				•		•		
Silvy	146		•	•	•			•	•	•		
Soffio	156		•	•	•			•				
King	160		•		•			•				
Sharon	162		•		•			•				
Elettra	166		•		•			•				
Guapa	168		•	•				•	•	•		•
Apelle	176		•	•		•		•	•	•		•
Ciak	186		•	•					•			•
F12	188		•		•			•				
Portofino	192		•		•				•			•
Www	196		•									•
Axial	198		•		•				•	•		
Marsiglia	200		•		•				•	•		•
Island	204		•		•				•			
Vivo	206		•	•	•				•		•	
H5	210		•		•				•		•	•
Istar	216		•		•						•	
Bongo	218	•	•		•	•				•		
John	220		•	•						•		
Mark	222		•	•	•	•				•		
Kayak	224		•			•				•		
Zow	226		•	•						•		
Happy Kreek	228		•		•					•		
Afra	230		•		•				•			•
Billy	232		•		•							•
Kasha	234		•	•	•							•
Relax	236		•	•	•							•
T.T. Relax	238		•		•							•
Mask	240		•		•							•



# Tavoli Tables

pag.	Basi - Base				Esterno Outdoor	Piani - Top						
	Metallo Metal	Legno Wood	Plastica Plastic	Vetro Glass		Legno Wood	Vetro Glass	HPL	Plastica Plastic	Metallo Metal	Cuoio Hide	
Armando	244	●									●	
Toronto	250	●	●			●	●					
Portofino	256	●				●	●					
London	260			●			●					
Drive	262	●					●					
Brioso	264	●					●					
Poker	268	●				●						
Sintesy	270	●				●		●	●			
Four	272	●				●		●				
Trampoliere	274	●			●	●		●	●			
Italia	276	●			●	●		●	●			
Break	278	●			●	●		●	●			
Infinity	280	●				●	●	●	●			
Face	284	●					●					
Composit	286	●				●	●	●	●			
Smart	290	●			●	●		●	●			
Dj	294	●										●
Walter	296	●									●	
Guapa	298	●										●
Apelle	300	●										●
Joint	302	●										●
Trip	304	●										●

# Italian know-how

Se capacità industriale e tecnologie avanzate sono la nostra forza, la maestria nel fare è la nostra anima, ciò che davvero ci distingue. Il saper fare rappresenta il cuore della nostra azienda: grazie ad esso tutti i nostri progetti prendono vitalità e slancio, a partire da una vocazione artigiana che viene ininterrottamente coltivata e perfezionata.

If industrial capacity and advanced technology are our strength, the know-how skill is our soul, what really sets us apart. The know-how is the heart of our company: thanks to it all our projects take vitality and outburst, from a handcrafted vocation that is continuously cultivated and perfected.











# Cordovado, Pordenone, Italy

L'Italia per noi non è solo un luogo di produzione ma va ben oltre: è il modo di pensare e di vivere che abbiamo abbracciato nel progettare, interpretare e innovare l'idea di arredamento fin dal 1987. Non solo Made in Italy quindi ma una perfetta sinergia tra maestria artigianale, creatività e tecnologia che rendono il nostro modo di lavorare il valore aggiunto in ogni nostra creazione.

Italy does not just define a place of production, but goes beyond: for us, it indicates a way of thinking and living, that we embraced in designing and innovating the idea of furniture since 1987. Not just Made in Italy, but a perfect synergy between hand - craft modeling, creativity and technology, that makes our working method the added value in each product.









Design  
Paolo Vernier  
Nenè







**.01**

NENÈ L sedia legno L40, L26, NENÈ S-TS sedia polipropilene P07, tessuto 375, NENÈ CAP polipropilene P05, tessuto 368, Nenè SR-SF ecopelle 738, NENÈ S polipropilene P07, P18, P08, P27, P05, P04, Nenè PR-SF ecopelle 714.

NENÈ L wooden chair L40, L26, NENÈ S-TS polypropylene chair P07, fabric 375, NENÈ CAP polypropylene chair P05, fabric 368, Nenè SR-SF ecoleather 738, NENÈ S polypropylene P07, P18, P08, P27, P05, P04, Nenè PR-SF ecoleather 714.

**.02 .03 .04**

NENÈ S polipropilene P05, P07,

T. SMART tavolo bistrot in acciaio Y, piano LS5.

NENÈ S polipropilene P05, P07,

T. SMART bistro table with steel frame Y, top LS5.





**.05 .06**  
NENÈ S polipropilene P04,  
ARMANDO tavolo fisso in acciaio D.  
NENÈ S polypropylene chair P04,  
ARMANDO fix table with steel frame D.





**.07.09**  
NENÉ L sedia legno L26,  
ARMANDO tavolo fisso in acciaio D.  
NENÉ L wooden chair L26,  
ARMANDO fix table with steel frame D.











**.08**  
NENÈ L sedia legno L40.  
NENÈ L wooden chair L40.

**.10**  
NENÈ CAP polipropilene P05, tessuto 368.  
NENÈ CAP polypropylene chair P05, fabric 368.



**.11**  
NENÈ SR-CF ecopelle 718,  
NENÈ PR-SF ecopelle 714.  
NENÈ SR-CF ecoleather 718,  
NENÈ PR-SF ecoleather 714..

**.12**  
NENÈ SR-SF ecopelle 722,  
LONDON tavolo fisso 200x110, piano vetro VE5.  
NENÈ SR-SF ecoleather 722,  
LONDON fix table 200x110, glass top VE5.

**.13**  
NENÈ S polipropilene P18.  
NENÈ S polypropylene chair P18.









S



L



S-CU



S-TS



CAP



SR-CF



SR-SF



P-TS



P-CU



PR-CF



PR-SF

### Nenè S, L

Sedia con struttura in polipropilene o legno di frassino. - Chair in polypropylene or ash wood. - Chaise avec structure en polypropylène ou frêne. - Stuhl aus Polypropylen oder Asche. - Silla con estructura en polipropileno o madera de fresno. - Стул с основанием из полипропилена или из ясеня.

### Nenè CAP, S-CU, S-TS, P-CU, P-TS

Sedia e poltrona con struttura in polipropilene, sedile e schienale rivestiti. - Chair and armchair with polypropylene frame, seat and back upholstered. - Chaise et fauteuil avec structure en polypropylène, assise et dossier revêtus. - Stuhl und Armstuhl mit Polypropylen Struktur, gepolsterte Sitz und Lehne. - Silla y sillón con estructura en polipropileno asiento y respaldo tapizado - Стул и кресло с основанием в полипропилена, спинка и сиденье обитые.

### Nenè SR-CF, SR-SF, PR-CF, PR-SF

Sedia e poltrona con struttura in polipropilene, completamente rivestita. - Chair and armchair with polypropylene frame, fully upholstered. - Chaise et fauteuil avec structure en polypropylène, complètement revêtue. - Stuhl und Armstuhl mit Polypropylen Struktur, komplett gepolstert. - Silla y sillón con estructura con estructura en polipropileno totalmente tapizada. - Стул и кресло с основанием в полипропилена, полностью обитое.

Struttura - Frame - Structure - Gestell - Estructura - Каркас

Struttura - Frame - Structure - Gestell - Estructura - Каркас

Seduta e schienale - Seat and back - Assise et dossier - Sitz Und Lehne - Asiento y respaldo - сидение и спинка

Struttura, seduta e schienale - Structure, seat and back - Structure, assise et dossier - Gestell, Sitz Und Lehne - Каркас, Сидение И Спинка

### S

Polipropilene - Polypropylene - Polypropylène - Polypropylene - Polipropileno - Полипропилен

P05 Bianco - White

P06 Grigio cielo - Sky grey

P07 Sabbia - Sand

P04 Nero - Black

P08 Rosso - Red

P18 Verde - Green

P27 Lilla - Lilac

### L

Legni - Wood - Bois - Holz - Madera - Дерево

L40 Rovere naturale - Natural Oak

L26 Rovere moro - Dark Oak

L14 Noce - Walnut

Polipropilene - Polypropylene - Polypropylène - Polypropylene - Polipropileno - Полипропилен

P05 Bianco - White

P06 Grigio cielo - Sky grey

P07 Sabbia - Sand

P04 Nero - Black

P08 Rosso - Red

P18 Verde - Green

P27 Lilla - Lilac

### S-CU, P-CU

Cuoio - Hide - Cuir - Kernleder - Cuero - Naturальная Кожа

Cuoio rigenerato - Rigenated hide - Cuir régénéré - Rigeneriertes leder - Cuero regenerado - Регенерированная Кожа

### CAP, S-TS, P-TS

Pelle - Leather - Peau - Leder- Piel - Naturальная кожа

Ecopelle - Ecoleather - Similicuir - Kunstleder - Ecopiel - Искусственная Кожа

Tessuto - Fabric - Tissu - Stoff - Tejido - Ткань

Vedi campionario per scegliere il colore - Check the swatches for colours - Voir l'échantillon pour choisir la couleur - Siehe Musterkarte um die Farbe zu wählen - Смотреть образцы для выбора цвета

Pelle - Leather - Peau - Leder- Piel - Naturальная кожа

Ecopelle - Ecoleather - Similicuir - Kunstleder - Ecopiel - Искусственная Кожа

Tessuto - Fabric - Tissu - Stoff - Tejido - Ткань

Vedi campionario per scegliere il colore - Check the swatches for colours - Voir l'échantillon pour choisir la couleur - Siehe Musterkarte um die Farbe zu wählen - Смотреть образцы для выбора цвета

### Dimensioni - Dimensions - Dimensions - Abmessung - Dimensiones - Размеры

#### Nenè S, L, CAP, S-CU, S-TS, SR-CF, SR-SF

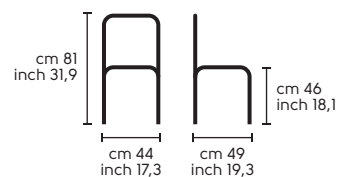

#### Nenè P-CU, P-TS, PR-CF, PR-SF

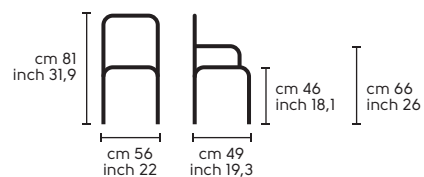

Design  
Archivoltto

# Liù







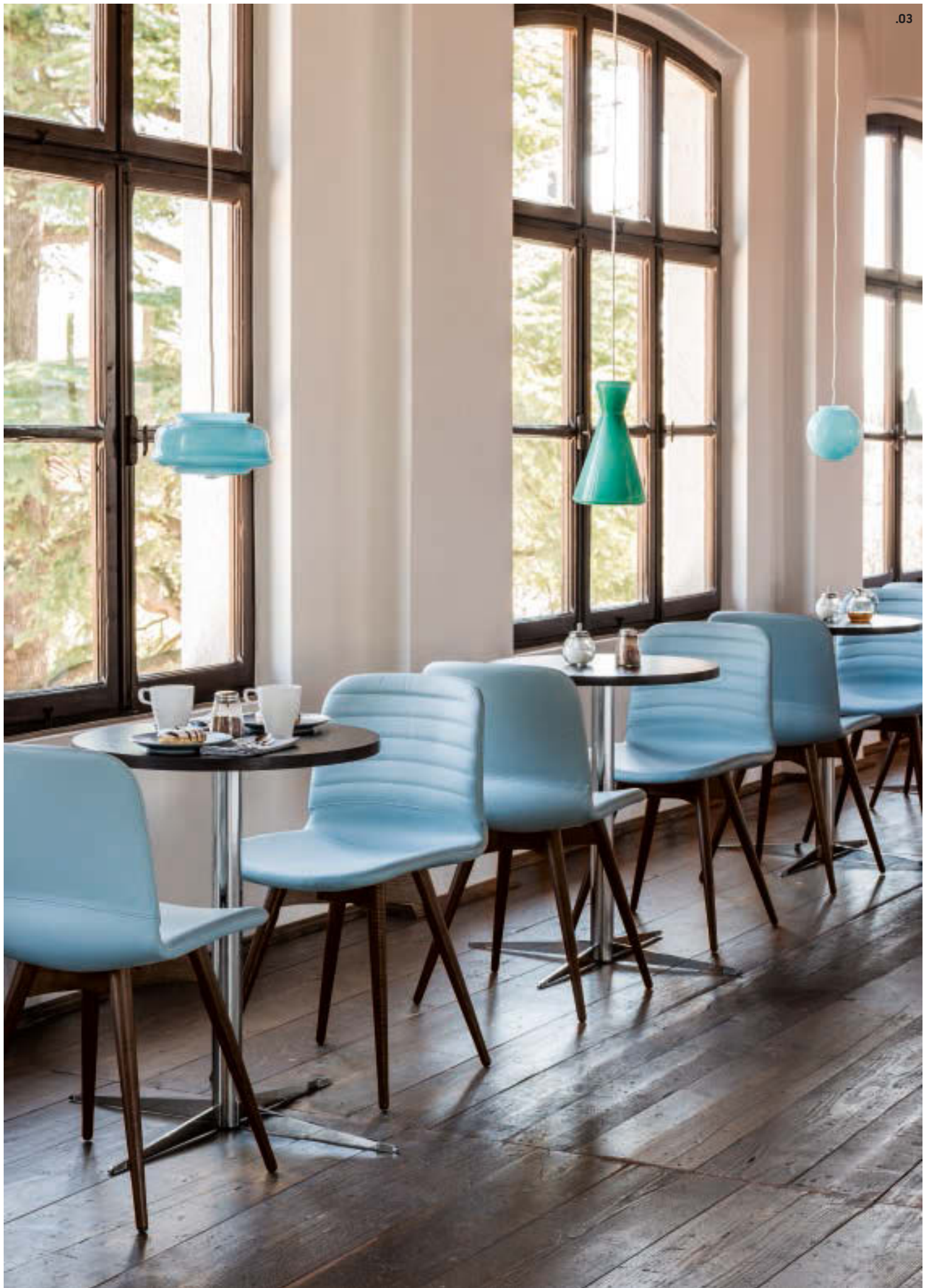

**.01**  
LIÙ S acciaio Y, tessuto 631, 632, 633.  
LIÙ S with steel frame Y, fabric 631, 632, 633.

**.02**  
LIÙ L sedia legno L40, tessuto 473.  
LIÙ L wooden chair L40, fabric 473.

**.03**  
LIÙ L sedia legno L26, pelle F09.  
LIÙ L wooden chair L26, leather F09.





**.04**

LIÙ P acciaio C, restylon R07,  
LIÙ P acciaio C, restylon R05.  
LIÙ P with steel frame C, restylon R07,  
LIÙ P with steel frame C, restylon R05.

**.05**

LIÙ S acciaio C, restylon R08, R05, R06.  
LIÙ S with steel frame C, restylon R08, R05, R06.



**.05**





**.06**

LIÙ D acciaio C, ecopelle 722,

LIÙ DP acciaio C, ecopelle 722,

ARMANDO tavolo fisso 160x90 in acciaio Y.

LIÙ D with steel frame C, ecoleather 722,

LIÙ DP with steel frame, ecoleather 722,

ARMANDO fix table 160x90 with steel frame Y.



.07  
LIÙ T acciaio C, restylon R05.  
LIÙ T with steel frame C, restylon R05.



## Liù

Sedia e poltrona, fissa e con base a 5 razze, con struttura in legno, acciaio cromato o verniciato. Scocca in Restylon® o imbottita. - Fixed and 5 ways base chair and armchair, with wooden structure, painted or chromed steel. Shell in Restylon® or upholstered. - Chaise et fauteuil, fixes et 5 rayons, avec structure en bois, en acier chromé ou laqué. Assise en Restylon® ou revêtue. - Stuhl und Armstuhl mit fest und 5 Speichen Gestell, mit Holz, lackiert oder verchromt Stahl Struktur.

Schale aus Restylon® oder gepolsterte. - Silla y sillón fija y con base de 5 palos, estructura en madera, acero barnizado o cromado. Carcasa en Restylon® o tapizada. - Стул и кресло, фиксированное и на основании крестовине-пятилучье, с основание из дерева, крашенной или хромированной стали. Каркас из пластика Restylon® или обитый.

### Struttura - Frame - Structure - Gestell - Estructura - Структура

#### S, P, T, C, X

Acciaio - Steel - Acier - Stahl - Acero



**Y**  
Bianco - White



**R**  
Alluminio - Aluminium



**S**  
Corda - Corda



**C**  
Cromo - Chrome

#### L

Legni - Wood - Bois - Holz - Madera - Дерево



**L40**  
Rovere naturale - Natural Oak



**L26**  
Rovere moro - Dark Oak

#### CR, D, DP

Acciaio - Steel - Acier - Stahl - Acero



**C**  
Cromo - Chrome

### Scocca - Shell - Assise - Schale - Carcasa - Сидение И Спинка

Pelle - Leather - Peau - Leder - Piel - Натуральная кожа

Ecopelle - Ecoleather - Similicuir - Kunstleder - Ecopiel - Искусственная Кожа

Tessuto - Fabric - Tissu - Stoff - Tejido - Ткань

Restylon - Restylon - Restylon - Restylon - Restylon - Пластика Restylon

Vedi campionario per scegliere il colore - Check the swatches for colours - Voir l'échantillon pour choisir la couleur - Siehe Musterkarte um die Farbe zu wählen - Смотреть образцы для выбора цвета

### Dimensioni - Dimensions - Dimensions - Abmessung - Dimensiones - Размеры

#### Liù L-R, L-TS, C-R, C-TS, CR-TS

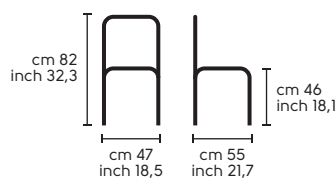

#### Liù S-R, S-TS, T-R, T-TS

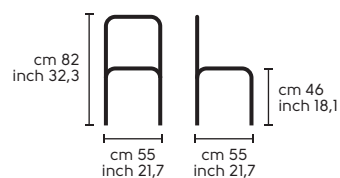

#### Liù P-R, P-TS

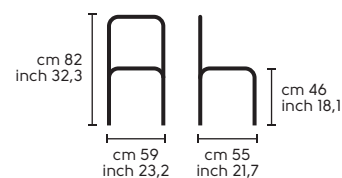

#### Liù X-R, X-TS

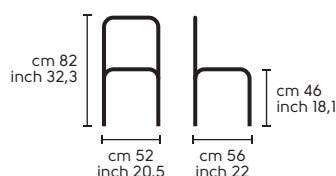

#### Liù D-R, D-TS

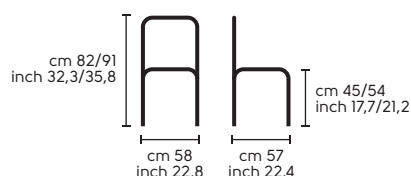

#### Liù DP-R, DP-TS

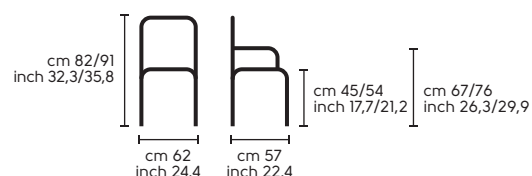

Design  
Area44

# Raff



**.01**

RAFF S acciaio Y, baydur P05.  
ARMANDO tavolo fisso 80x80 in acciaio Y  
RAFF S with steel frame Y, baydur P05.  
ARMANDO fix table 80x80 with steel frame Y

**.02**

RAFF T acciaio C, baydur P05.  
RAFF T with steel frame C, baydur P05.

**.02**











.04



.05

**.03**

RAFF S acciaio Y, baydur P02.  
SMART tavolo bistrot in acciaio Y,  
piano HPL LS5

RAFF S with steel frame Y, baydur P02.  
SMART bistrot table with steel frame Y,  
op HPL LS5

**.04**

RAFF PA3T acciaio C, baydur P05.  
RAFF PA3T with steel frame C, baydur P05.

**.05**

RAFF S acciaio C, baydur P22,  
RAFF S acciaio C, baydur P51,  
RAFF T acciaio C, baydur P05.  
RAFF S with steel frame C, baydur P22,  
RAFF S with steel frame C, baydur P51,  
RAFF T with steel frame C, baydur P05.



S



T



D



L



GT



F



SG

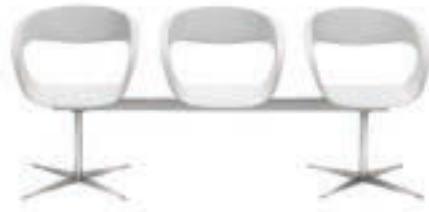

PA3



PA4

**Raff S-B, S-TS, T-B, T-TS, L-B, L-TS, GT-B, GT-TS, F-B, F-TS, D-B, D-TS, SG-B, SG-TS**

Poltrona fissa, sgabello, poltrona con base girevole e 5 razze, con struttura in legno, acciaio cromato o verniciato. Scocca in Baydur® o imbottita. - Fixed armchair, stool and armchair with swivel and 5 ways base, with wooden, painted or chromed steel structure. Shell in Baydur® or upholstered. - Fauteuil fixe, tabouret, fauteuil pivotante avec base à 5 rayons. Structure en bois, acier chromé ou laqué. Assise en Baydur® ou revêtue. - Fest Armstuhl, Hocker und Armstuhl fest und 5 Speichen Gestell, mit Holz, lackiert oder verchromt Stahl Struktur. Schale aus Restylon® oder gepolsterte. - Sillon fijo, taburete, sillón con base giratoria de 5 palos, con estructura en madera, acero cromado o barnizado. Carcasa en Baydur® o tapizada. - Кресло с фиксированным основанием, барный стул, кресло на вращающемся основании крестовине-пятилучье; основание в дереве, из хромированной или крашенной стали. Каркас в пластике Baydur® или обитый.

**Raff PA2T-B, PA2T-TS, PA3-B, PA3-TS, PA3T-B, PA3T-TS, PA4-B, PA4-TS**

Panca a 2, 3 o 4 posti, con struttura in acciaio cromato. Scocca in Baydur® o imbottita. - 2, 3 or 4 seaters bench, with chromed steel frame. Baydur® or upholstered shell. - Banquette à 2, 3, 4 sièges, avec structure en acier chromé. Assise en Baydur® ou revêtue. - 2,3 oder 4 Sitz Bank, verchromt Stahl Struktur. Schale aus Restylon® oder gepolsterte. - Bancada de 2, 3 o 4 asientos con estructura en acero cromado. Carcasa Baydur® o tapizada. - Скамейка 2х, 3х или 4хместная, с основанием в хромированной стали. Каркас в пластике Baydur® или обитый.

**Struttura - Frame - Structure - Gestell - Estructura - Структура**

**S, T, F**

Acciaio - Steel - Acier - Stahl - Acero - Сталь

**Y**  
Bianco - White

**D**  
Grigio cenere - Ash gray

**C**  
Cromo - Chrome

**GT, D, SG, PA2, PA3, PA4**

Acciaio - Steel - Acier - Stahl - Acero - Сталь

**C**  
Cromo - Chrome

**L**

Legni - Wood - Bois - Holz - Madera - Дерево

**L40**  
Rovere naturale - Natural Oak

**L26**  
Rovere moro - Dark Oak

**Scocca - Shell - Assise - Schale - Carcasa - Сидение И Спинка**

Baydur

Pelle - Leather - Peau - Leder - Piel - Натуральная кожа

Ecopelle - Ecoleather - Similicuir - Kunstleder - Ecopiel - Искусственная Кожа

Tessuto - Fabric - Tissu - Stoff - Tejido - Ткань

Vedi campionario per scegliere il colore - Check the swatches for colours - Voir l'échantillon pour choisir la couleur - Siehe Musterkarte um die Farbe zu wählen - Смотреть образцы для выбора цвета

**Piano - Top - Plateau - Platte - Sobre - Столешница**

**PA2T-B, PA3T-B**

HPL

**Dimensioni - Dimensions - Dimensions - Abmessung - Dimensiones - Размеры**

**Raff S-B, S-TS, T-B, T-TS, L-B, L-TS**

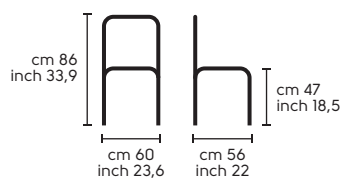

**Raff GT-B, GT-TS, F-B, F-TS, D-B, D-TS**

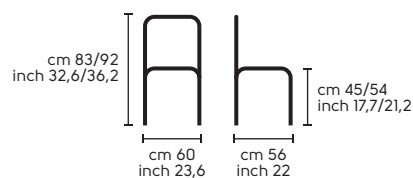

**Raff SG-B, SG-TS**

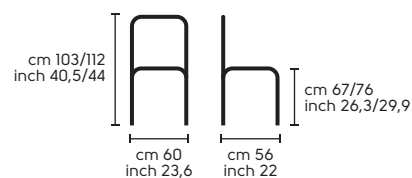

**Raff PA2T-B, PA2T-TS, PA3-B, PA3-TS**

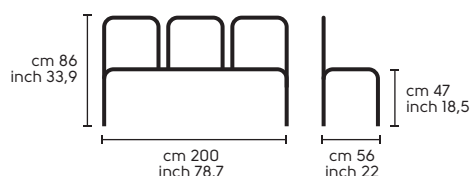

**Raff PA3T-B, PA3-TS, PA4-B, PA4-TS**

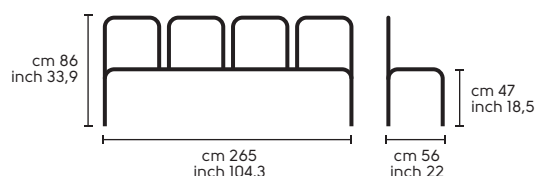

Design  
Design R&D  
Twist





**.01**  
TWIST S acciaio C, Hirek HR5.  
TWIST S with steel frame C, Hirek HR5.

**.02**  
TWIST S acciaio C, Hirek HR5.,  
TWIST F acciaio C, Hirek HR8,  
TWIST GO acciaio C, Hirek HR4.  
TWIST S with steel frame C, Hirek HR5,  
TWIST F with steel frame C, Hirek HR8,  
TWIST GO with steel frame C, Hirek HR4.







**.03**  
TWIST I acciaio Y, Hirek HR5,  
COMPOSIT basamento bistrot acciaio Y,  
piano HPL LS5.  
TWIST I with steel frame Y, Hirek HR5,  
COMPOSIT bistro base in steel Y, top HPL LS5

**.04**  
TWIST F acciaio C, tessuto 464,  
TWIST F acciaio C, Hirek HR5.  
TWIST F with steel frame C, fabric 464,  
TWIST F with steel frame C, Hirek HR5.

**.05**  
TWIST D acciaio C, Hirek HR5.  
TWIST D with metal frame C, Hirek HR5.







**.06**  
TWIST PA4 acciaio C, Hirek HR5, piano HPL LS5.  
TWIST PA4 with steel frame C, Hirek HR5, top HPL LS5.



**Twist**

Sedia fissa e girevole con struttura in legno, acciaio cromato o verniciato. Scocca in Hirec® o imbottita.  
 - Fix and swivel chair with wooden structure, chromed or painted steel. Shell in Hirec® or upholstered.  
 Chaise fixe et pivotante avec structure en bois, acier chromé ou laqué. Assise en Hirec® ou revêtue.  
 - Fest und drehbar Stuhl mit Holz, verchromt oder lackiert Stahl Struktur.

Schale aus Hirec® oder gepolsterte. - Silla fija y giratoria con estructura en madera, acero cromado o barnizado. Carcasa en Hirec® o tapizada. - Стул на неврвращающемся и вращающемся основании, с основанием из дерев, хромированной или крашенной стали. Каркас из пластики Hirec® или обитый.

**Struttura - Frame - Structure - Gestell - Estructura - Структура**

**S, I**

Acciaio - Steel - Acier - Stahl - Acero - Сталь

**Y**  
Bianco - White

**R**  
Alluminio - Aluminium

**C**  
Cromo - Chrome

**GO**

Acciaio - Steel - Acier - Stahl - Acero - Сталь

**C**  
Cromo - Chrome

**K**  
Satinato - Satin

**F**

Acciaio - Steel - Acier - Stahl - Acero - Сталь

**C**  
Cromo - Chrome

**L**

Legni - Wood - Bois - Holz - Madera - Дерево

**L40**  
Rovere naturale - Natural Oak

**L26**  
Rovere moro - Dark Oak

**Scocca - Shell - Assise - Schale - Carcasa - Сидение И Спинка**

Hirek - Hirek - Hirek - Hirek - Hirek - Hirek - Пластика Hirek

Pelle Vintage - Vintage leather - Peau vintage - Vintage leder - Vintage piel - Винтажная кожа

Ecopelle - Ecoleather - Similicuir - Kunstleder - Ecopiel - Искусственная Кожа

Tessuto - Fabric - Tissu - Stoff - Tejido - Ткань

Vedi campionario per scegliere il colore - Check the swatches for colours - Voir l'échantillon pour choisir la couleur - Siehe Musterkarte um die Farbe zu wählen - Смотреть образцы для выбора цвета

**Dimensioni - Dimensions - Dimensions - Abmessung - Dimensiones - Размеры**

**Twist L-H, S-H, S-TS, I-H, I-TS, GO-H, GO-TS, F-H, F-TS**

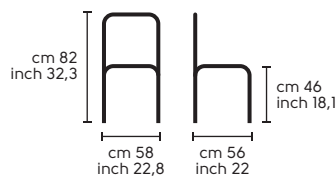

**Twist P2T, P3**

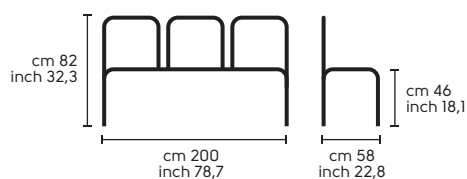

**Twist P3T, P4**

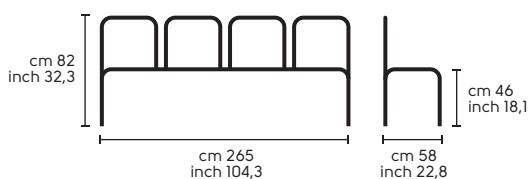

Design  
sempere#poli

# Jadé



**.01 .02 .03**  
JADÈ S legno L40.  
JADÈ S wood L40.





**.04**  
JADÈ S legno L40,  
ARMANDO 160x90 tavolo fisso acciaio Y.  
JADÈ S wood L40,  
ARMANDO 160x90 fix table with steel frame Y.

**.05**  
JADÈ S legno L26.  
JADÈ S wood L26.









**Jade**

Sedia, poltrona, attesa e sgabello in legno in diverse finiture. - Chair, armchair, lounge chair and stool with wooden frame in different finishes. - Chair, fauteuil, accueil et tabouret en bois en différent finitions. - Stuhl, Armstuhl, Lounge Stuhl und Hocker mit Holz Gestell verschiedene Ausfuehrungen. - Silla, sillón,

espeira y taburete en madera en diversos acabados. - Стул, кресло, лаунж-кресло и барный стул с основанием в разных отделках дерева.

**Struttura - Frame - Structure - Gestell - Estructura - Структура**

Legni - Wood - Bois - Holz - Madera - Дерево

- L14**  
Noce - Walnut
- L26**  
Rovere moro - Dark Oak
- L40**  
Rovere naturale - Natural Oak
- Y**  
Bianco - White
- F**  
Nero - Black

**Dimensioni - Dimensions - Dimensions - Abmessung - Dimensiones - Размеры**

**Jade S**

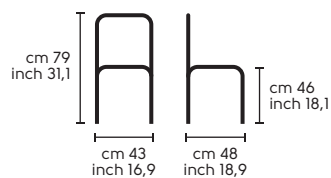

**Jade P**

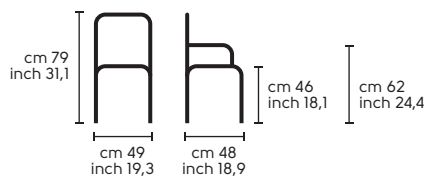

**Jade ATT**

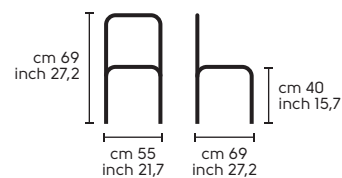

**Jade H65**

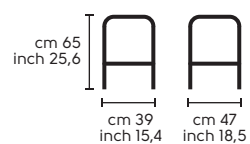

**Jade H75**

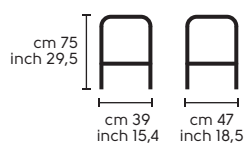

**Jade Pouf**

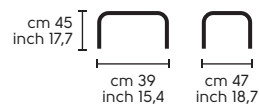

Design  
Midj R&D

# Joe





**.01**

JOE L-LG legno L40, sedile e schienale legno L40, JOE L-TS legno L40, sedile e schienale fabric 473, JOE L-CU legno L40, sedile e schienale cuoio U53, JOE M-TSL acciaio G, sedile ecopelle 464, schienale ecopelle 464 + legno L14, JOE M-TS acciaio G, sedile e schienale ecopelle 473, JOE M-LF acciaio G, sedile e schienale legno L14.

JOE L-LG wood L40, wooden seat and back L40, JOE L-TS wood L40, seat and back fabric 473, JOE L-CU wood L40, seat and back hide U53, JOE M-TSL with steel frame G, ecoleather 464 seat, ecoleather 464 + wood L14 back, JOE M-TS with steel frame G, seat and back ecoleather 473, JOE M-LF with steel frame G, wooden L14 seat and back.

**.02**

JOE L-TSL legno L40, sedile e schienale ecopelle 464 + legno L40, JOE M-TSL acciaio G, sedile ecopelle 464, schienale ecopelle 464 + legno L14.

JOE L-TSL wood L40, ecoleather 464 seat and back + wood L40, JOE M-TSL with steel frame G, ecoleather 464 seat, ecoleather 464 + wood L14 back.

**.03**

JOE L-LG legno L40.  
JOE L-LG wood L40.

**.04**

JOE M-CU acciaio G, sedile e schienale cuoio U66.  
JOE M-CU with steel frame G, hide U66 seat and back.

**Joe L-TS, L-CU, L-LG**

Sedia con struttura in legno in diverse finiture. Sedile e schienale imbottiti, in cuoio o impiallacciato in diverse finiture. - Chair with wooden frame in different finishes. Upholstered seat and back in different finishes. - Chaise avec structure en bois en différentes finitions. Assise et dossier revêtus, en cuir ou plaqué en différentes finitions. - Stuhl, Armstuhl, Lounge Stuhl und Hocker mit Holz Gestell verschiedene Ausführungen. Gepolsterte Sitz und Lehne verschiedene Ausführungen. - Silla con estructura en madera en diversos acabados. Asiento y respaldo tapizado, en cuero o contrachapado en diversos acabados. - Стул с основанием в разных отделках дерева. Спинка и сиденье обитые, в коже или в разных отделках шпона.

**Joe M-LF, M-TS, M-CU, M-LG**

Sedia con struttura in acciaio verniciato. Sedile e schienale imbottiti, in cuoio o impiallacciato in diverse finiture. - Chair with painted steel frame. Upholstered seat and back in different finishes. - Chaise avec structure en acier laqué. Assise et dossier revêtus, en cuir ou plaqué en différentes finitions. - Stuhl mit lackiertem Stahl Gestell. Gepolsterte Sitz und Lehne verschiedene Ausführungen. - Silla con estructura de acero barnizado. Asiento y respaldo tapizado, en cuero o contrachapado en diversos acabados. - Стул с основанием в крашенной стали. Спинка и сиденье обитые, в коже или в разных отделках шпона.

**Struttura - Frame - Structure - Gestell - Estructura - Структура****L-TS, L-CU, L-LG, L-TSL**

Legno - Wood - Bois - Holz - Madera - Дерево

**L14**  
Noce - Walnut

**L26**  
Rovere moro - Dark Oak

**L40**  
Rovere naturale - Natural Oak

**M-LF, M-TS, M-CU, M-LG, M-TSL**

Acciaio - Steel - Acier - Stahl - Acero - Сталь

**Y**  
Bianco - White

**R**  
Alluminio - Aluminium

**S**  
Corda - Corda

**G**  
Grafite - Grafite

**T**  
Testa di moro - Dark Brown

**Seduta e schienale - Seat and back - Assise et dossier - Sitz Und Lehne - Asiento y respaldo - сидение и спинка****L-CU, M-CU**

Cuoio - Hide - Cuir - Kernleder - Cuero - Натуральная Кожа

Cuoio rigenerato - Rogenerated hide - Synderme - Rigeneriertes leder - Cuero regenerado - Регенерированная Кожа

**L-TS, M-TS, L-TSL, M-TSL**

Pelle - Leather - Peau - Leder - Piel - Натуральная кожа

Ecopelle - Ecoleather - Similicuir - Kunstleder - Ecopiel - Искусственная Кожа

Tessuto - Fabric - Tissu - Stoff - Tejido - Ткань

**L-LG, M-LF, M-LG**

Impiallacciato - Veneered wood - Bois plaqué - Holz furniert - Madera contra-Chapada - Шпон

**L14**  
Noce - Walnut

**L26**  
Rovere moro - Dark Oak

**L40**  
Rovere naturale - Natural Oak

Vedi campionario per scegliere il colore - Check the swatches for colours - Voir l'échantillon pour choisir la couleur - Siehe Musterkarte um die Farbe zu wählen - Смотреть образцы для выбора цвета

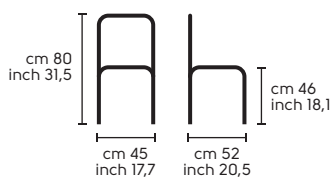
**Dimensioni - Dimensions - Dimensions - Abmessung - Dimensiones - Размеры****Joe**

Design  
Midj R&D

# Sonny







**.01**  
SONNY P MT acciaio C, pelle F18, SONNY S MT acciaio C, pelle F18, SONNY S LG legno L40, pelle F18, SONNY P LG legno L40, pelle F18.  
SONNY P MT with steel frame C, leather F18, SONNY S MT with steel frame C, leather F18, SONNY S LG wood L40, leather F18, SONNY P LG wood L40, leather F18.





**.02**  
SONNY P LG legno L40, pelle F09.  
SONNY P LG wood L40, leather F09.

**.03**  
SONNY S LG legno L40, pelle F09.  
SONNY S LG wood L40, leather F09.



**Sonny S-MT, P-MT**

Sedia e poltrona con struttura in acciaio cromato o verniciato. Scocca imbottita. - Chair and armchair with chrome or painted frame. Upholstered shell. - Chaise et fauteuil avec structure en acier chromé or laqué. Assise revêtue. - Stuhl und Armstuhl mit verchromt oder lackiert Gestell. Gespolsterte Schale. - Silla y sillón con estructura en acero cromado o barnizado. Carcasa tapizada. - Стул и кресло с основанием в хромированной или крашенной стали. Каркас обитый.

**Sonny S-LG, P-LG**

Sedia e poltrona con struttura in legno in diverse finiture. Scocca imbottita. - Chair and armchair with wooden frame. Upholstered shell. - Chaise et fauteuil avec structure en bois en différentes finitions. Assise revêtue. - Stuhl und Armstuhl mit Holz Gestell. Gespolsterte Schale. - Silla y sillón con estructura de madera en diversos acabados. Carcasa tapizada. - Стул и кресло с основанием в разных отделках дерева. Каркас обитый.

**Struttura - Frame - Structure - Gestell - Estructura - Структура****S-MT, P-MT**

Acciaio - Steel - Acier - Stahl - Acero - Сталь



**C**  
Cromo - Chrome



**Y**  
Bianco - White

**S-LG, P-LG**

Legni - Wood - Bois - Holz - Madera - Дерево



**L14**  
Noce - Walnut



**L26**  
Rovere moro - Dark Oak



**L40**  
Rovere naturale - Natural Oak



**Y**  
Bianco - White

**Seduta e schienale - Seat and back - Assise et dossier - Sitz Und Lehne - Asiento y respaldo - сидение и спинка**

Pelle - Leather - Peau - Leder - Piel - Натуральная кожа

Ecopelle - Ecoleather - Similicuir - Kunstleder - Ecopiel - Искусственная Кожа

Tessuto - Fabric - Tissu - Stoff - Tejido - Ткань

Vedi campionario per scegliere il colore - Check the swatches for colours - Voir l'échantillon pour choisir la couleur - Siehe Musterkarte um die Farbe zu wählen - Смотреть образцы для выбора цвета

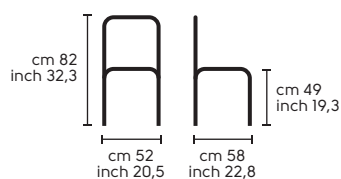
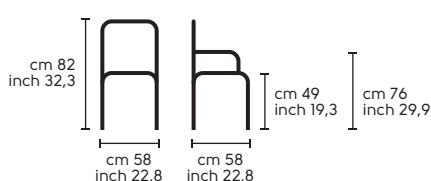
**Dimensioni - Dimensions - Dimensions - Abmessung - Dimensiones - Размеры****Sonny S-MT, S-LG****Sonny P-MT, P-LG**

Design  
Paolo Vernier

# Matrix

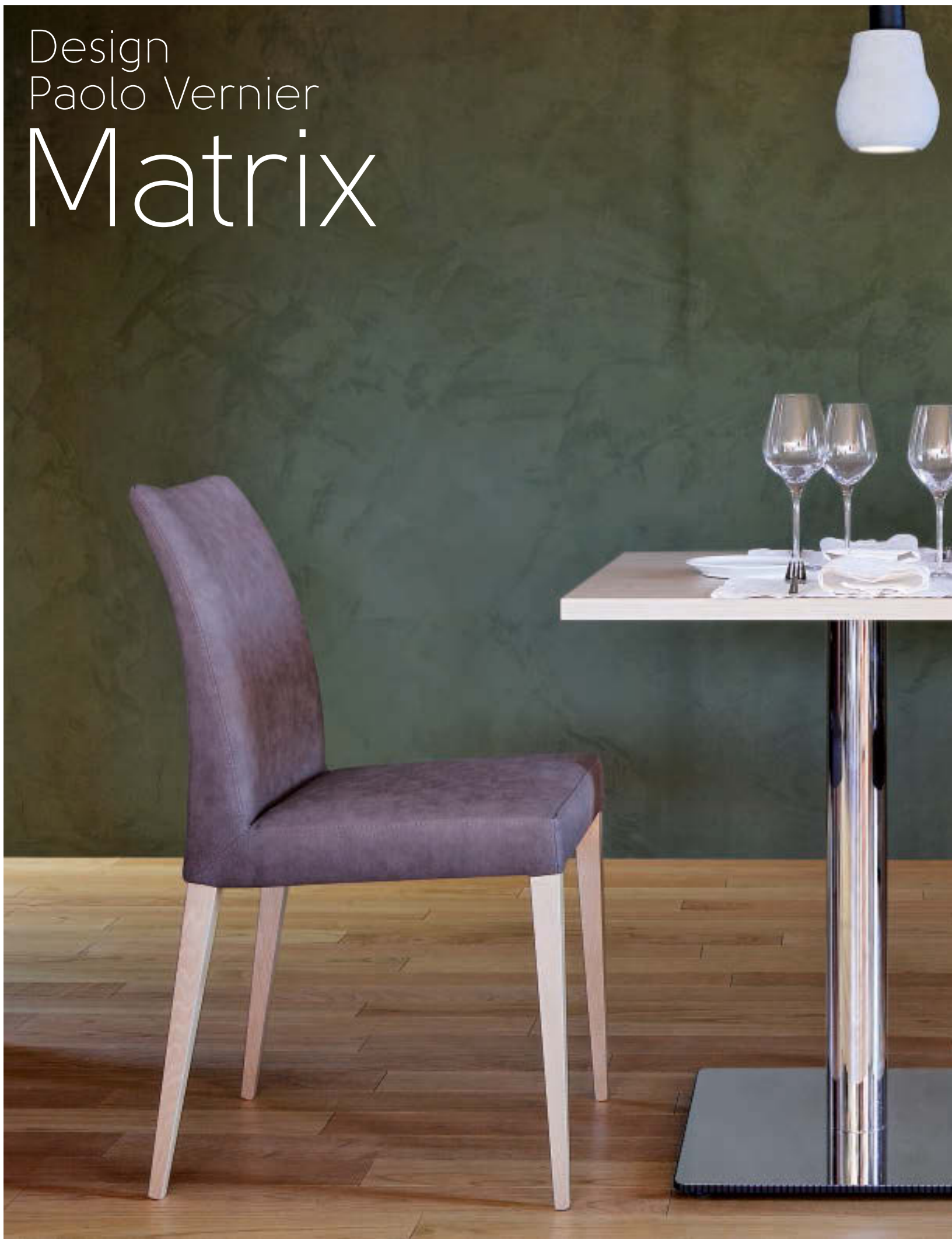





**.01**  
MATRIX S legno L40, ecopelle 7V4,  
COMPOSIT 2 tavolo bistrot in acciaio C, piano L40.  
MATRIX S wood L40, ecopelle 7V4,  
COMPOSIT 2 bistrot table with steel frame C, top L40.



**.02**  
MATRIX S legno L26, tessuto 375,  
MATRIX P legno L26, tessuto 375,  
MATRIX H75 legno L26, tessuto 375.  
Matrix S wood L26, fabric 375,  
MATRIX P wood L26, fabric 375,  
MATRIX H75 wood L26, fabric 375.



**Matrix**  
 Sedia, poltrona e sgabello con struttura in legno di diverse finiture. Seduta imbottita. - Chair, armchair and stool with wooden frame in different finishes. Upholstered shell. - Chaise, fauteuil et tabouret avec structure en bois en différentes finitions. Assise revêtue. - Stuhl, Armstuhl und Hocker mit Holz Gestell aus verschiedenen Ausführungen. Gepolsterte Schale. - Silla, sillón y taburete con estructura en madera en diversos acabados. Asiento tapizado. - Стул, кресло и барный стул с основанием в разных оттенках дерева. Сиденье обитое.

**Struttura - Frame - Structure - Gestell - Estructura - Структура**

Legno - Wood - Bois - Holz - Madera - Дерево

-  **L26**  
Rovere moro - Dark Oak
-  **L40**  
Rovere naturale - Natural Oak

**Scocca - Shell - Assise - Schale - Carcasa - Сидение И Спинка**

Pelle - Leather - Peau - Leder - Piel - Натуральная кожа

Ecopelle - Ecoleather - Similicuir - Kunstleder - Ecopiel - Искусственная Кожа

Tessuto - Fabric - Tissu - Stoff - Tejido - Ткань

Vedi campionario per scegliere il colore - Check the swatches for colours - Voir l'échantillon pour choisir la couleur - Siehe Musterkarte um die Farbe zu wählen - Ver muestras para elegir el color - Смотреть образцы для выбора цвета

**Dimensioni - Dimensions - Dimensions - Abmessung - Dimensiones - Размеры**

**Matrix S-LG**

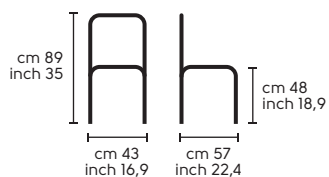

**Matrix P-LG**

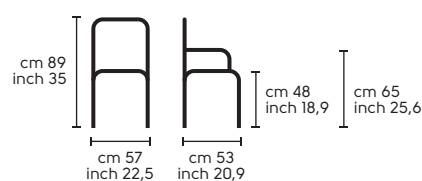

**Matrix H75-LG**

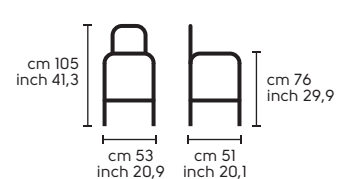

Design  
Natalie Santin

# Marilyn













**.01**

MARILYN S LG legno L26, ecopelle 736 + 710, MARILYN P LG legno L26, ecopelle 736 + 710, MARILYN S MT acciaio S, ecopelle 722 + 375, MARILYN P MT acciaio S, ecopelle 722 + 375.

MARILYN S LG wood L26, ecoleather 736 + 710, MARILYN P LG wood L26, ecoleather 736 + 710, MARILYN S MT with steel frame S, ecoleather 722 + 375, MARILYN P MT with steel frame S, ecoleather 722 + 375.

**.02 .03**

MARILYN S MT acciaio D, pelle F18 + 710, ARMANDO tavolo fisso 80x80 acciaio D, MARILYN S C acciaio Y, tessuto 369 + 710, MARILYN P C acciaio Y, tessuto 369 + 710.

MARILYN S MT with steel frame D, leather F18 + 710, ARMANDO fix table 80x80 with steel frame D, MARILYN S C with steel frame Y, fabric 369 + 710, MARILYN P C with steel frame Y, fabric 369 + 710.



**Marilyn**  
 Sedia e poltrona con struttura in legno in diverse finiture. Sedile e schienale imbottiti. - Chair and armchair with wooden frame. Upholstered seat and back. - Chaise, fauteuil et tabouret avec structure en bois en différentes finitions. Assise et dossier revêtus. - Stuhl und Armstuhl mit Holz Gestell. Gespolsterte Sitz und Lehne. - Silla y sillón con estructura en madera en diversos acabados. Asiento y respaldo tapizado. - Стул и кресло с основанием в разных отделках дерева. Сиденье и спинка обитые.

**Struttura - Frame - Structure - Gestell - Estructura - Структура**

S-LG, P-LG  
 Legno - Wood - Bois - Holz - Madera - Дерево

- Y**  
Bianco - White
- L14**  
Noce - Walnut
- L26**  
Rovere moro - Dark Oak
- L40**  
Rovere naturale - Natural Oak

S-C, P-C  
 Acciaio - Steel - Acier - Stahl - Acero - Сталь

- Y**  
Bianco - White
- C**  
Cromo - Chrome

S-MT, P-MT  
 Acciaio - Steel - Acier - Stahl - Acero - Сталь

- Y**  
Bianco - White
- S**  
Corda - Corda
- D**  
Grigio cenere - Ash gray

**Scocca - Shell - Assise - Schale - Carcasa - Сидение И Спинка**

Pelle - Leather - Peau - Leder - Piel - Натуральная кожа

Ecopelle - Ecoleather - Similicuir - Kunstleder - Ecopiel - Искусственная Кожа

Tessuto - Fabric - Tissu - Stoff - Tejido - Ткань

Vedi campionario per scegliere il colore - Check the swatches for colours - Voir l'échantillon pour choisir la couleur - Siehe Musterkarte um die Farbe zu wählen - Ver muestras para elegir el color - Смотреть образцы для выбора цвета

**Dimensioni - Dimensions - Dimensions - Abmessung - Dimensiones - Размеры**

**Marilyn S-LG, S-C, S-MT**

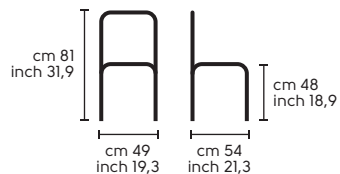

**Marilyn P-LG, P-C, P-MT**

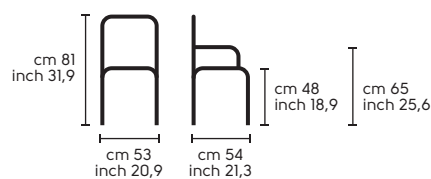

Design  
Midj R&D

# Cover











**.01**  
COVER ATT-T acciaio C, pelle F09.  
COVER ATT-T with steel frame C, leather F09.

**.02**  
COVER ATT-T acciaio C, tessuto 368.  
COVER ATT-T with steel frame C, fabric 368.

**.03**  
COVER L legno L05, tessuto 371.  
COVER L wood L05, fabric 371.





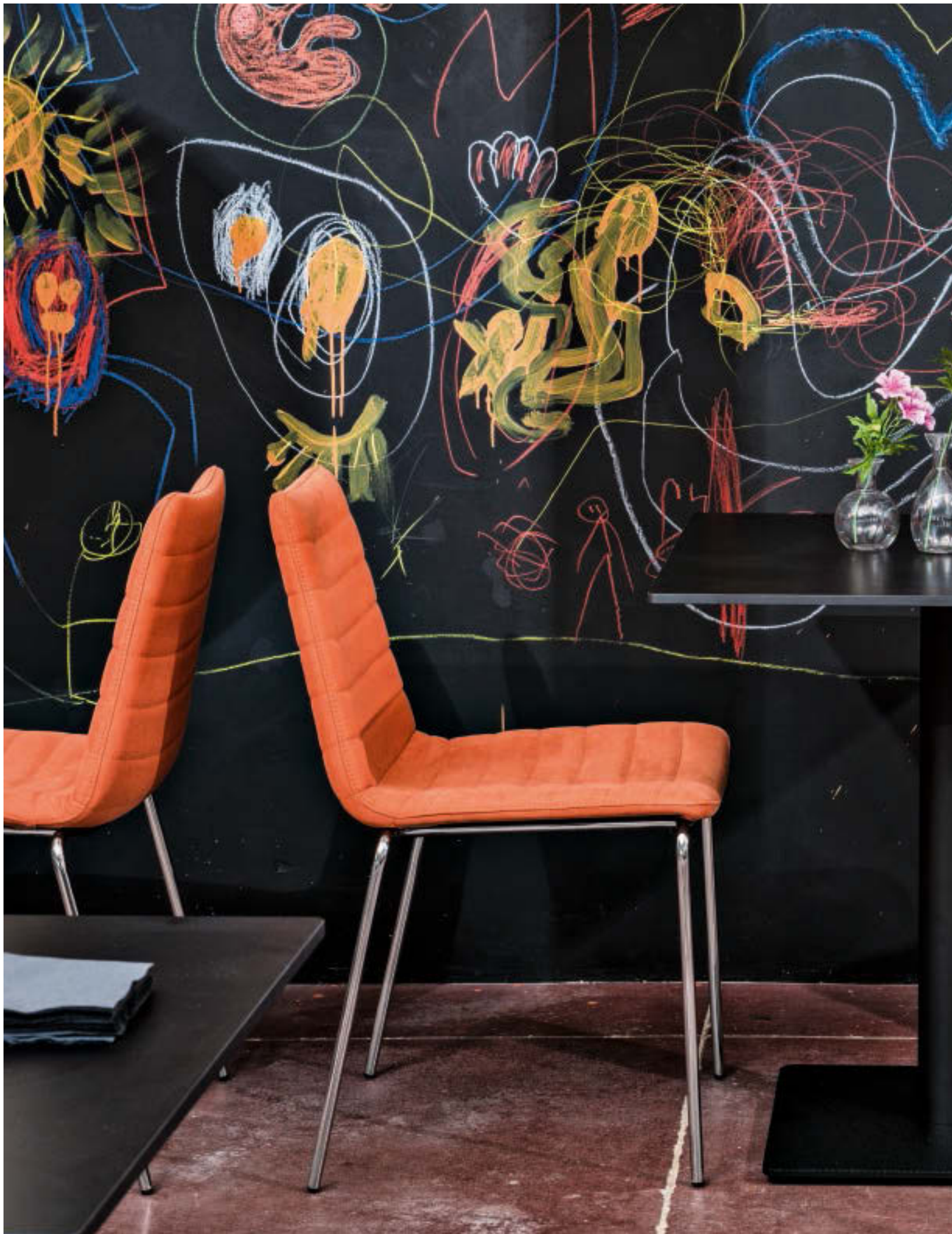





**.04 .05**  
COVER S acciaio C, tessuto 365,  
COMPOSIT/I basamento bistrot acciaio F, piano HPL LS4.  
COVER S with steel frame C, fabric 365,  
COMPOSIT/I bistro base with steel frame F, top HPL LS4.



.06  
COVER H65 acciaio C, ecopelle 373.  
COVER H65 with steel frame C, ecoleather 373.







**.07**

COVER S acciaio Y, ecopelle 722.

COVER S with steel frame Y, ecoleather 722.

**.08**

COVER P acciaio C, ecopelle 730, kit unione acciaio C.

COVER P, with steel frame C, ecoleather 730, union kit in steel C





### Cover

Sedia, poltrona, sgabello, attesa fissa e girevole, con struttura in legno, acciaio cromato o verniciato. Scocca imbottita. - Chair, armchair, stool, fix or swivel lounge chair with wooden structure, chromed or painted steel. Upholstered shell. - Chaise, fauteuil, tabouret, accueil fixe et pivotante avec structure en bois, acier chromé ou laqué. Assise revêtue. - Stuhl, Armstuhl, Hocker, Lounge Stuhl fest oder

drehbar mit Holz, lackiert oder verchromt Stahl Struktur. Gepolsterte Schale. - Silla, sillón, taburete, espera fija o giratoria. Estructura en madera, acero cromado o barnizado. Carcasa tapizada. - Стул, кресло, барный стул, лаунж-кресло фиксированное и вращающееся, с основанием в дереве, хромированной стали или крашенным. Каркас обитый.

### Struttura - Frame - Structure - Gestell - Estructura - Каркас

#### S, T, P, PT, H65, H75

Acciaio - Steel - Acier - Stahl - Acero - Сталь

**Y**  
Bianco - White

**R**  
Alluminio - Aluminium

**C**  
Cromo - Chrome

#### L

Legni - Wood - Bois - Holz - Madera - Дерево

**L40**  
Rovere naturale - Natural Oak

**L26**  
Rovere moro - Dark Oak

**D05**  
Bianco - White

#### ATT-F

Acciaio - Steel - Acier - Stahl - Acero - Сталь

**C**  
Cromo - Chrome

### Seduta e schienale - Seat and back - Assise et dossier - Sitz Und Lehne - Asiento y respaldo - сидение и спинка

Pelle - Leather - Peau - Leder - Piel - Натуральная кожа

Ecopelle - Ecoleather - Similicuir - Kunstleder - Escopiel - Искусственная Кожа

Tessuto - Fabric - Tissu - Stoff - Tejido - Ткань

Vedi campionario per scegliere il colore - Check the swatches for colours - Voir l'échantillon pour choisir la couleur - Siehe Musterkarte um die Farbe zu wählen - Смотреть образцы для выбора цвета

### Dimensioni - Dimensions - Dimensions - Abmessung - Dimensiones - Размеры

#### Cover L, S, T

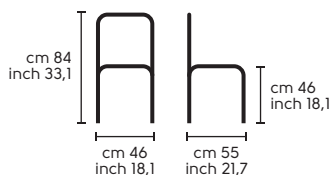

#### Cover P

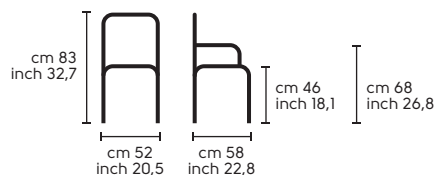

#### Cover PT

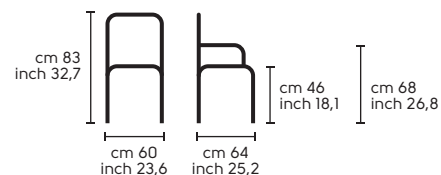

#### Cover H65

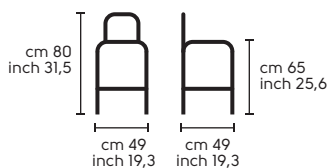

#### Cover H75

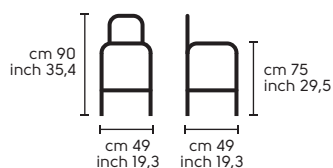

#### Cover ATT-T, ATT-F

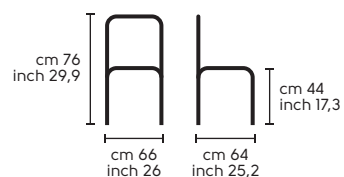

Design  
Midj R&D

# Krono







**.01**  
KRONO acciaio Y, tessuto 369,  
POKER acciaio Y, impiallacciato L40.  
KRONO with steel frame Y, fabric 639,  
POKER with steel strame Y, veneered L40 top.

**.02**  
KRONO acciaio C, ecopelle 733.  
KRONO with steel frame C, ecoleather 733.

**.03**  
KRONO acciaio C, tessuto 63N, 63R.  
KRONO with steel frame C, fabric 63N, 63R.



**Krono**  
 Sedia con struttura in acciaio cromato o verniciato. Scocca rivestita. - Chair with steel structure, chrome or laquered. Shell fully upholstered. - Chaise avec structure en acier chromé ou laqué. Assise revêtue. - Stuhl mit Gestell aus Stahl, verchromt oder lackiert. Schale komplett bezogen.

- Silla con estructura en acero cromado o lacado. Carcasa tapizada. - Стул со стальным каркасом: хром или лак. Спинка и сидение обиты.

**Struttura - Frame - Structure - Gestell - Estructura - Каркас**

Acciaio - Steel - Acier - Stahl - Acero - Сталь

**Y**  
 Bianco - White

**R**  
 Alluminio - Aluminium

**C**  
 Cromo - Chrome

**Seduta e schienale - Seat and back - Assise et dossier - Sitz Und Lehne - Asiento y respaldo - сидение и спинка**

Pelle - Leather - Peau - Leder- Piel - Натуральная кожа

Ecopelle - Ecoleather - Similicuir - Kunstleder - Ecopiel - Искусственная Кожа

Tessuto - Fabric - Tissu - Stoff - Tejido- Ткань

Vedi campionario per scegliere il colore - Check the swatches for colours - Voir l'échantillon pour choisir la couleur - Siehe Musterkarte um die Farbe zu wählen - Смотреть образцы для выбора цвета

**Dimensioni - Dimensions - Dimensions - Abmessung - Dimensiones - Размеры**

**Krono**

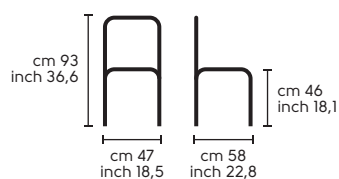

Design  
Paolo Vernier  
Zelig







**.01**  
ZELIG S-TS acciaio C, ecopelle 738,  
ZELIG S acciaio C, legno L26.  
ZELIG S-TS/R with steel frame C, ecoleather 738,  
ZELIG S-LG with steel frame C, wood L26.

**.02**  
ZELIG S-TS acciaio C, ecopelle 722.  
ZELIG S-TS/R with steel frame C, ecoleather 722.



.03

ZELIG S-PL acciaio C, policarbonato H30.

ZELIG S-PL with steel frame C, polycarbonate H30



P



DP



### Zelig

Sedia e poltrona, fissa e con base a 5 razze, con struttura in acciaio cromato o verniciato. Scocca in policarbonato, imbottita o in legno. - Chair and armchair, fixed and with 5 ways base with chromed or painted steel. Polycarbonate, upholstered or wood shell. - Chaise et fauteuil, fixes et 5 rayons, avec structure en acier chromé ou laqué. Assise en polycarbonate, revêtue ou en bois. - Zelig Stuhl und Armstuhl, fest und mit 5 Mit 5-Fußkreuzgestell mit lackierter oder verchromter Struktur.

Schale aus Polycarbonate oder mit Postering. - Silla y sillón fija y con base 5 palos con estructura en acero cromado o barnizado. Carcasa en polycarbonato, tapizada o en madera. - Стул и кресло, фиксированное и на основании крестовине-пятилучье; основание в отделке крашеная или хромированная сталь. Каркас из поликарбоната, обитый или в дереве.

### Struttura - Frame - Structure - Gestell - Estructura - Структура

#### S, P

Acciaio - Steel - Acier - Stahl - Acero



Y  
Bianco - White



R  
Alluminio - Aluminium



C  
Cromo - Chrome

#### DP

Acciaio - Steel - Acier - Stahl - Acero



C  
Cromo - Chrome

### Scocca - Shell - Assise - Schale - Carcasa - Сидение И Спинка

Polycarbonato - Polycarbonate - Polycarbonate - Polycarbonato - Поликарбонат

Impiallacciato - Veneered Wood - Bois Plaqué - Holz Furniert - Madera - Contra-Chapada - Шпон

Pelle - Leather - Peau - Leder - Piel - Натуральная кожа

Ecopelle - Ecoleather - Similiticuir - Kunstleder - Escopiel - Искусственная Кожа

Tessuto - Fabric - Tissu - Stoff - Tejido - Ткань

Vedi campionario per scegliere il colore - Check the swatches for colours - Voir l'échantillon pour choisir la couleur - Siehe Musterkarte um die Farbe zu wählen - Смотреть образцы для выбора цвета

### Dimensioni - Dimensions - Dimensions - Abmessung - Dimensiones - Размеры

#### Zelig S-PL, S-LG, S-TS

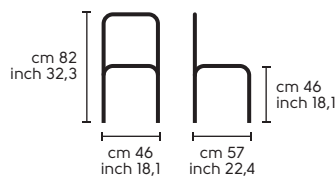

#### Zelig P-PL, P-LG, P-TS

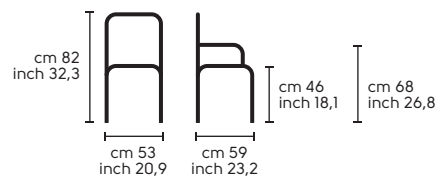

#### Zelig DP-PL, DP-LG, DP-TS

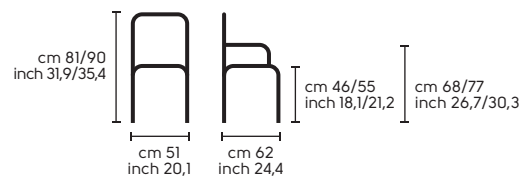

Design  
Roberto Paoli

# Trampoliere



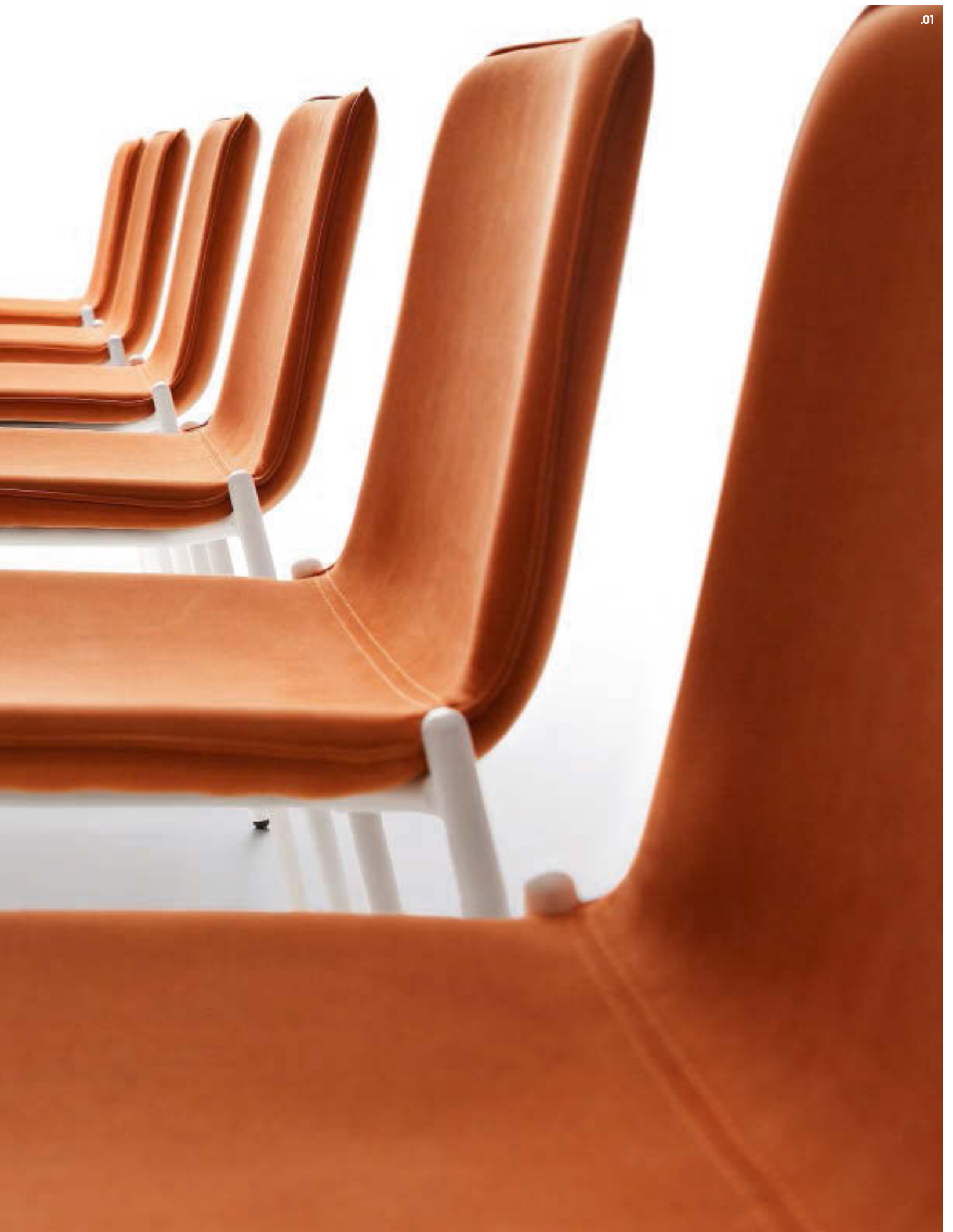













**.01**  
 TRAMPOLIERE S acciaio Y, tessuto 365.  
 TRAMPOLIERE S with steel frame Y, fabric 365.

**.02**  
 TRAMPOLIERE S acciaio Y, tessuto 369, 365, 368.  
 TRAMPOLIERE S with steel frame Y, fabric 369, 365, 368.

**.03**  
 TRAMPOLIERE S acciaio Y, tessuto 37A,  
 TRAMPOLIERE basamento bistrot acciaio Y, piano HPL LS5.  
 TRAMPOLIERE S with steel frame Y, fabric 37A,  
 TRAMPOLIERE bistro base in steel Y, top HPL LS5.

**.04**  
 TRAMPOLIERE H75 acciaio C, ecopelle 714,  
 731, 736.  
 TRAMPOLIERE H75 with steel frame C,  
 ecoleather 714, 731, 736.



S



P



H65, H75

#### Trampoliere

Sedia, poltrona e sgabello con struttura in acciaio cromato o verniciato. Scocca imbottita. - Chair, armchair and stool with chrome and painted steel frame. Upholstered shell. - Chaise, fauteuil et tabouret fix et pivotant en acier chromé ou laqué. Assise revêtue. - Stuhl, Armstuhl und Hocker mit

verchromt oder lackiert Stahl Struktur. Gepolsterte Schale. - Silla, sillón y taburete con estructura en acero cromado o barnizado. Carcasa tapizada. - Стул, кресло и барный стул с основанием в хромированной или крашенной стали. Сиденье обитое.

#### Struttura - Frame - Structure - Gestell - Estructura - Структура

Acciaio - Steel - Acier - Stahl - Acero - Сталь



Y  
Bianco - White



D  
Grigio cenere - Ash gray



C  
Cromo - Chrome

#### Scocca - Shell - Assise - Schale - Carcasa - Сидение И Спинка

Pelle - Leather - Peau - Leder - Piel - Натуральная кожа

Ecopelle - Ecoleather - Similicuir - Kunstleder - Escopiel - Искусственная Кожа

Tessuto - Fabric - Tissu - Stoff - Tejido - Ткань

Vedi campionario per scegliere il colore - Check the swatches for colours - Voir l'échantillon pour choisir la couleur - Siehe Musterkarte um die Farbe zu wählen - Смотреть образцы для выбора цвета

#### Dimensioni - Dimensions - Dimensions - Abmessung - Dimensiones - Размеры

##### Trampoliere S

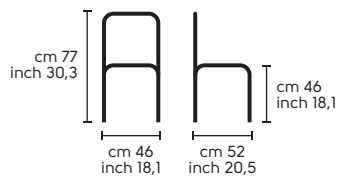

##### Trampoliere P

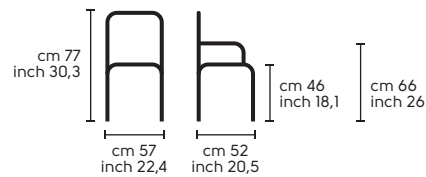

##### Trampoliere H65

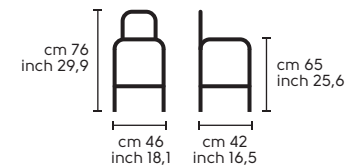

##### Trampoliere H75

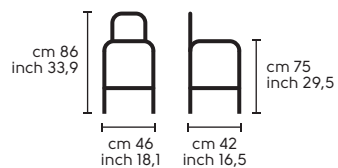

Design  
Jacopo Giagnoni  
Italia







**.01**  
ITALIA T acciaio C, ecopelle 737, 722, 733.  
ITALIA T with steel frame C, ecoleather 737,  
722, 733.

**.02**  
ITALIA X acciaio C, ecopelle 726,  
ITALIA basamento bistris acciaio C, piano HPL LS4.  
ITALIA X with steel frame C, ecoleather 726,  
ITALIA bistrot table, with steel frame C, HPL top LS4.



S



X



T



P



H65, H75



DP



DA

**Italia**

Sedia, poltrona, sgabello e dattilo con base a 5 razze, con struttura in acciaio cromato o verniciato. Seduta imbottita. - Chair, armchair, stool and 5 ways swivel base with chrome or painted steel frame. Upholstered shell. - Chaise, tabouret et fauteuil fix ou 5 rayons, avec structure en acier chromé ou laque. Assise revêtue. - Stuhl, Armstuhl, Hocker und 5 Speiche Gestell mit verchromt oder lackiert Stahl

Struktur, Gepolsterte Schale. - Silla, sillón, taburete y giratoria con base 5 palos con estructura en acero cromado o barnizado. Asiento tapizado. - Стул, кресло, барный стул и офисный стул на основании крестовине-пятилучье, с основанием в хромированной или крашенной стали. Сиденье обитое.

**Struttura - Frame - Structure - Gestell - Estructura - Структура**

T, S, X, P, H65, H75

Acciaio - Steel - Acier - Stahl - Acero - Сталь

**Y**  
Bianco - White

**D**  
Grigio cenere - Ash gray

**C**  
Cromo - Chrome

D-A, D-B, DP-A, DP-B

**C**  
Cromo - Chrome

**Scocca - Shell - Assise - Schale - Carcasa - Сидение И Спинка**

Pelle - Leather - Peau - Leder - Piel - Натуральная кожа

Ecopelle - Ecoleather - Similicuir - Kunstleder - Ecopiel - Искусственная Кожа

Tessuto - Fabric - Tissu - Stoff - Tejido - Ткань

Vedi campionario per scegliere il colore - Check the swatches for colours - Voir l'échantillon pour choisir la couleur - Siehe Musterkarte um die Farbe zu wählen - Смотреть образцы для выбора цвета

**Dimensioni - Dimensions - Dimensions - Abmessung - Dimensiones - Размеры**

**Italia T, S, X**

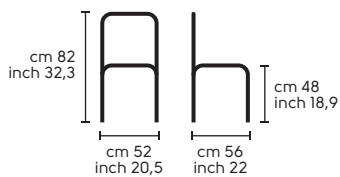

**Italia P**

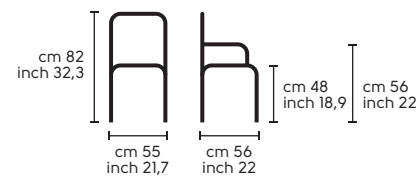

**Italia H65**

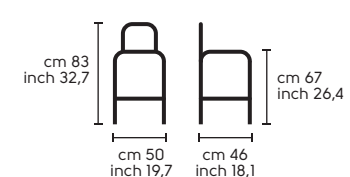

**Italia H75**

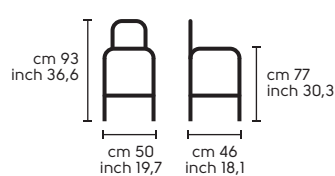

**Italia DA, DP-A**

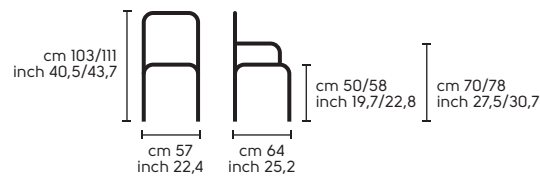

**Italia DB, DP-B**

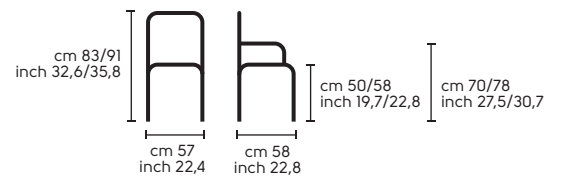

Design  
Studio Balutto associati  
Light







**.01**  
LIGHT B acciaio Y, tessuto 460.  
LIGHT B with steel frame Y, fabric 460.

**.02**  
LIGHT E acciaio C, tessuto 460.  
LIGHT E with steel frame C, fabric 460.





C



ATT



B



E



A



SG

**Light**

Sedia, poltrona, sgabello, attesa con struttura in acciaio cromato o verniciato. Scocca imbottita. - Chair, armchair, stool and lounge chair with chrome or painted steel frame. Upholstered shell. - Chaise, fauteuil, tabouret, accueil avec structure en acier chromé ou laqué. Assise revêtue. - Stuhl, Armstuhl,

Hocker und Lounge Stuhl mit verchromt oder lackiert Stahl Struktur. Gepolsterte Schale. - Silla, sillón, taburete, espera con estructura en acero cromado o barnizado. Carcasa tapizada. - Стул, кресло, барный стул, лаунж-кресло с основанием в хромированноч или крашенной стали. Каркас обитый.

**Struttura - Frame - Structure - Gestell - Estructura - Структура**

**A, B, C, E, ATT**

Acciaio - Steel - Acier - Stahl - Acero - Сталь

-  **Y** Bianco - White
-  **C** Cromo - Chrome

-  **SG** **C** Cromo - Chrome

**Scocca - Shell - Assise - Schale - Carcasa - Сидение И Спинка**

Pelle - Leather - Peau - Leder - Piel - Натуральная кожа

Ecopelle - Ecoleather - Similicuir - Kunstleder - Escopiel - Искусственная Кожа

Tessuto - Fabric - Tissu - Stoff - Tejido - Ткань

Vedi campionario per scegliere il colore - Check the swatches for colours - Voir l'échantillon pour choisir la couleur - Siehe Musterkarte um die Farbe zu wählen - Смотреть образцы для выбора цвета

**Dimensioni - Dimensions - Dimensions - Abmessung - Dimensiones - Размеры**

**Light A**

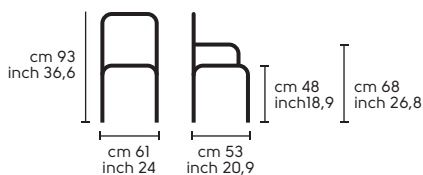

**Light B**

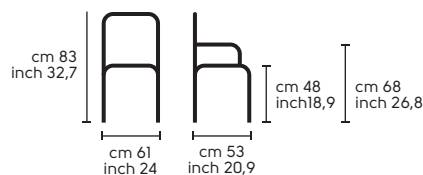

**Light C**

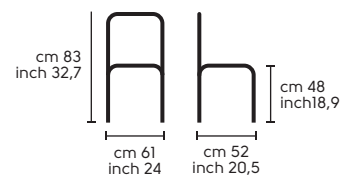

**Light E**

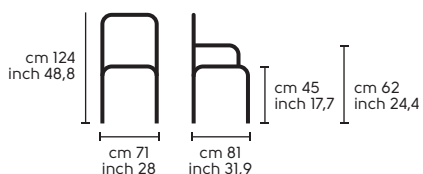

**Light ATT**

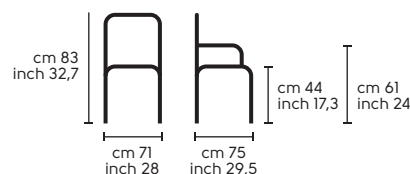

**Light SG**

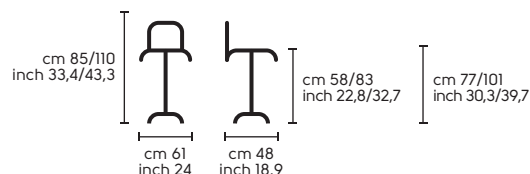

Design  
Design R&D

# Madame



**.01**  
 MADAME acciaio Y, ecopelle 722.  
 MADAME with steel frame Y,  
 ecoleather 722

**.02**  
 MADAME acciaio Y, ecopelle 722,  
 VITTORIO tavolo fisso acciaio Y,  
 piano melaminico M01.  
 MADAME with steel frame Y,  
 ecoleather 722,  
 VITTORIO fix table with steel  
 frame Y, melamine top M01.



**.02**

**Madame**

Poltrona con struttura in acciaio cromato o verniciato. Scocca imbottita. - Armchair with chrome or painted steel frame. Upholstered shell. - Fauteuil avec structure en acier chromé ou laqué. Assise revêtue. - Armstuhl mit verchromt oder lackiert Stahl Struktur. Gepolsterte Schale. - Sillon con

estructura en acero cromado o barnizado. Asiento tapizado - Кресло с основанием в хромированной или крашенной стали. Сиденье обитое.

**Struttura - Frame - Structure - Gestell - Estructura - Структура**

Acciaio - Steel - Acier - Stahl - Acero - Сталь



**Y**  
 Bianco - White



**C**  
 Cromo - Chrome

**Scocca - Shell - Assise - Schale - Carcasa - Сидение И Спинка**

Pelle - Leather - Peau - Leder - Piel - Натуральная кожа

Ecopelle - Ecoleather - Similicuir - Kunstleder - Ecopiel - Искусственная Кожа

Tessuto - Fabric - Tissu - Stoff - Tejido - Ткань

Vedi campionario per scegliere il colore - Check the swatches for colours - Voir l'échantillon pour choisir la couleur - Siehe Musterkarte um die Farbe zu wählen - Смотреть образцы для выбора цвета

**Dimensioni - Dimensions - Dimensions - Abmessung - Dimensiones - Размеры**

**Madame**

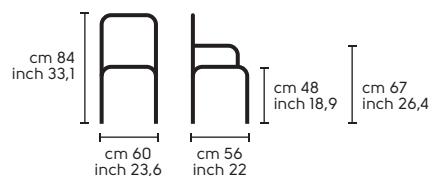

Design  
Midj R&D

# Revolution



.01

REVOLUTION S-CF acciaio Y,  
ecopelle 726.

REVOLUTION S-CF with steel  
frame Y, ecoleather 726



S-CF



S-SF



H65-CF, H75-CF



H65-SF, H75-SF

#### Revolution

Sedia e sgabello con struttura in acciaio cromato o verniciato. Sedile e schienale imbottito. - Chair and armchair with chrome or painted frame. Seat and back upholstered. - Chaise et tabouret avec structure en acier chromé ou laqué. Assise et dossier revêtus. - Stuhl und Armstuhl mit verchromt oder

lackiert Stahl Struktur. Gepolsterte Sitz und Lehne. - Silla y taburete con estructura en acero cromado o barnizado. Asiento y respaldo tapizado. - Стул и барный стул с основанием в хромированной или крашенной стали. Сиденье и спинка обитые.

#### Struttura - Frame - Structure - Gestell - Estructura - Структура

Acciaio - Steel - Acier - Stahl - Acero - Сталь



**Y**  
Bianco - White



**C**  
Cromo - Chrome

#### Seduta e schienale - Seat and back - Assise et dossier - Sitz Und Lehne - Asiento y respaldo - сидение и спинка

Pelle - Leather - Peau - Leder - Piel - Натуральная кожа

Ecopelle - Ecoleather - Similicuir - Kunstleder - Escopiel - Искусственная Кожа

Tessuto - Fabric - Tissu - Stoff - Tejido - Ткань

Vedi campionario per scegliere il colore - Check the swatches for colours - Voir l'échantillon pour choisir la couleur - Siehe Musterkarte um die Farbe zu wählen - Смотреть образцы для выбора цвета

#### Dimensioni - Dimensions - Dimensions - Abmessung - Dimensiones - Размеры

##### Revolution S-CF, S-SF

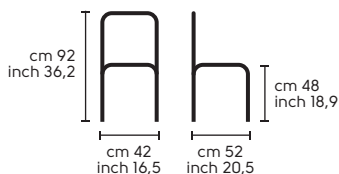

##### Revolution H65-CF, H65-SF

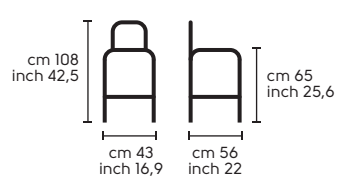

##### Revolution H75-CF, H75-SF

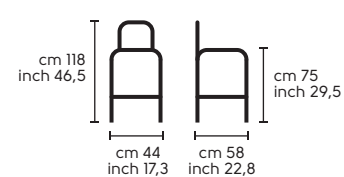

Design  
Paolo Vernier

# Imola/Prinz





**.01**  
 IMOLA CU acciaio C, cuoio U05.  
 IMOLA CU with steel frame C, hide U05



S



SG



CU

**Imola - Prinz**

Sedia e sgabello girevole e regolabile in altezza con struttura in acciaio cromato. Sedile e schienale rivestiti o imbottiti. - Chair, 5 ways base and high-adjustable stool with chrome steel structure. Upholstered seat and back. - Chaise, fauteuil à 5 rayons et tabouret pivotante et ajustable en hauteur. Assise et dossier en cuir ou revêtus. - Stuhl, 5 Speiche Gestell und verstellbar Hocker mit verchromt

Stahl Struktur. Gepolsterte Sitz und Lehne. - Silla, giratoria y taburete giratorio y regulable en altura con estructura en acero cromado. Asiento y respaldo en cuero o tapizado. - Стул, офисный стул и барный стул вращающийся и регулирующий по высоте, с основанием в хромированной стали. Сиденье и спинка обшитые полутвердой кожей (cuoio) обитые.

**Struttura - Frame - Structure - Gestell - Estructura - Каркас**

**Imola S, Prinz S**

Acciaio - Steel - Acier - Stahl - Acero - Сталь



**C**  
Cromo - Chrome

**Prinz SG**

Acciaio - Steel - Acier - Stahl - Acero - Сталь



**C**  
Cromo - Chrome



**K**  
Satinato - Satin

**Seduta e schienale - Seat and back - Assise et dossier - Sitz Und Lehne - Asiento y respaldo - сидение и спинка**

**Imola S**

Cuoio - Hide - Cuir - Kernleder - Cuero - Натуральная Кожа

**Prinz S, Prinz SG**

Pelle - Leather - Peau - Leder - Piel - Натуральная кожа

Ecopelle - Ecoleather - Similicuir - Kunstleder - Escopiel - Искусственная Кожа

Tessuto - Fabric - Tissu - Stoff - Tejido - Ткань

Vedi campionario per scegliere il colore - Check the swatches for colours - Voir l'échantillon pour choisir la couleur - Siehe Musterkarte um die Farbe zu wählen - Смотреть образцы для выбора цвета

**Dimensioni - Dimensions - Dimensions - Abmessung - Dimensiones - Размеры**

**Imola**

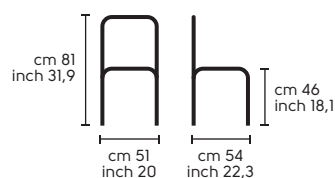

**Prinz S**

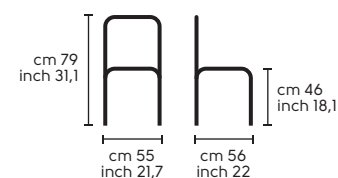

**Prinz SG**

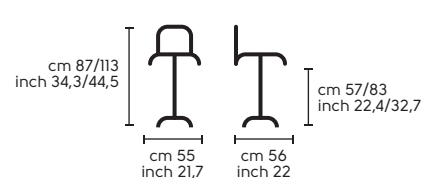

Design  
Midj R&D

# Stone



**.01**  
 STONE SG acciaio C, ecopelle 722.  
 STONE SG with steel frame C,  
 ecoleather 722.



S



P



H65, H75

**Stone**  
 Sedia, poltrona, sgabello fisso e girevole con struttura in acciaio cromato o verniciato. Seduta imbottita.  
 - Chair, armchair, fix and swivel stool with chrome or painted steel frame. Upholstered shell. - Chaise,  
 fauteuil, tabouret fixe et pivotant avec structure en acier chromé ou laqué. Assise revêtue. - Stuhl,  
 Armstuhl, fest und drehbar Hocker mit verchromt oder lackiert Stahl Struktur. Gepolsterte Schale. - Silla,  
 sillón, taburete fijo y giratorio con estructura en acero cromado o barnizado. Asiento tapizado. - Стул,  
 кресло, барный стул фиксированный или вращающийся с основанием в хромированной или  
 крашенной стали. Сиденье обитое.

**Struttura - Frame - Structure - Gestell - Estructura - Структура**

S, P, H65, H75

Acciaio - Steel - Acier - Stahl - Acero - Сталь



**R**  
 Alluminio - Aluminium



**C**  
 Cromo - Chrome

SG



**C**  
 Cromo - Chrome

**Scocca - Shell - Assise - Schale - Carcasa - Сидение И Спинка**

Pelle - Leather - Peau - Leder - Piel - Натуральная кожа

Ecopelle - Ecoleather - Similicuir - Kunstleder - Ecopiel - Искусственная Кожа

Tessuto - Fabric - Tissu - Stoff - Tejido - Ткань

Vedi campionario per scegliere il colore - Check the swatches for colours - Voir l'échantillon pour choisir la couleur - Siehe Musterkarte um die Farbe zu wählen - Смотреть образцы для выбора цвета

**Dimensioni - Dimensions - Dimensions - Abmessung - Dimensiones - Размеры**

Stone S

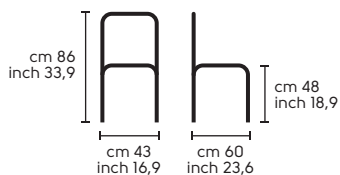

Stone P

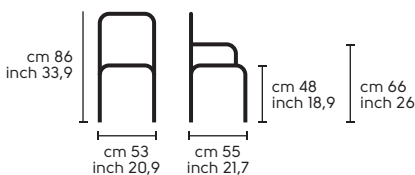

Stone H65

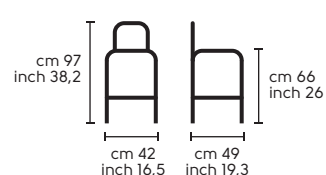

Stone H75

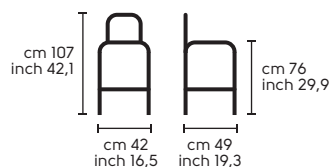

Stone SG

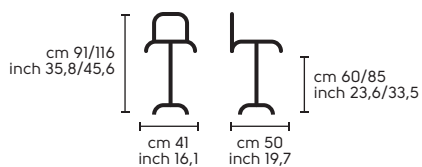

Design  
Midj R&D

# Passepartout





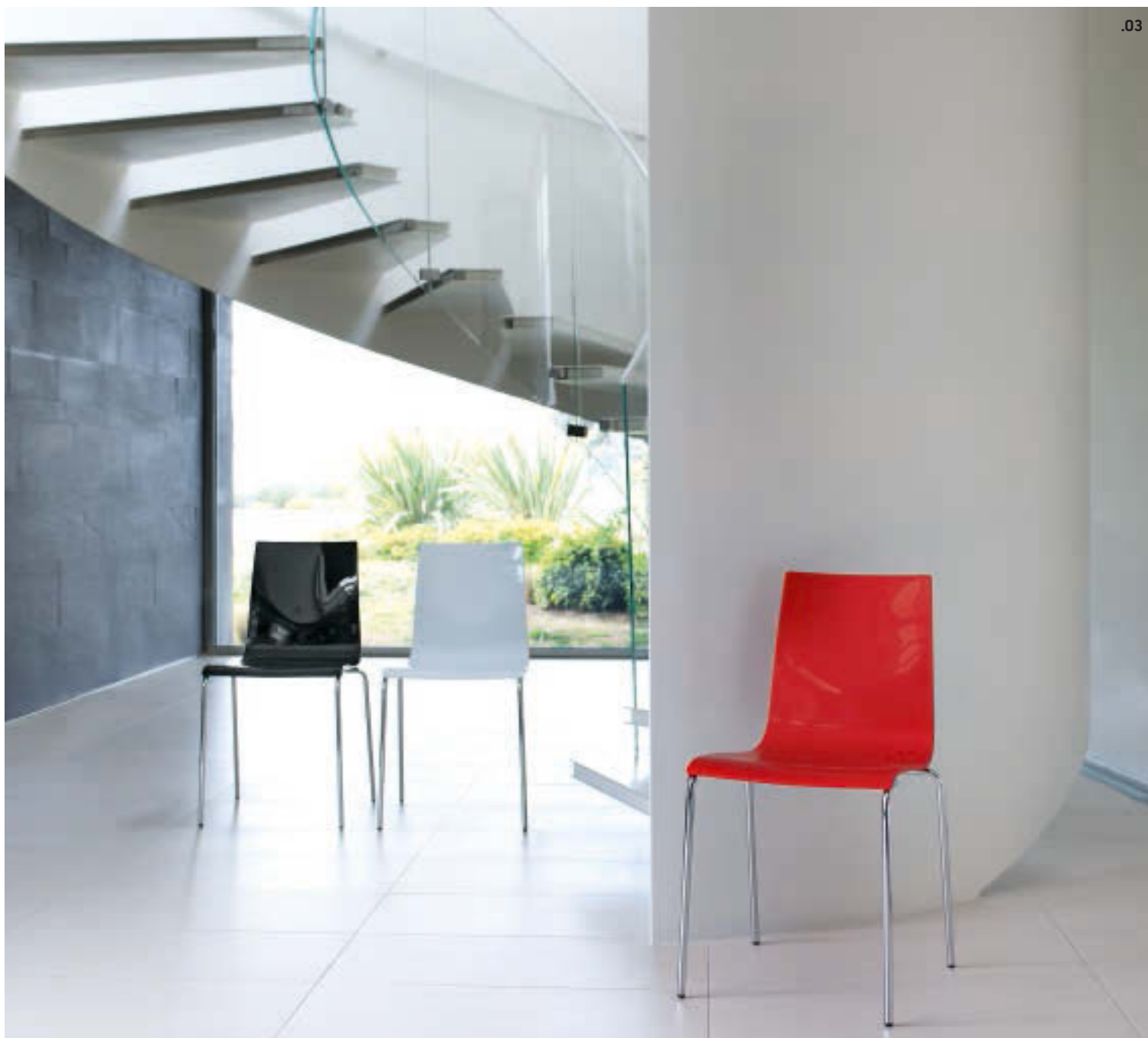

**.01**  
PASSEPARTOUT S acciaio C, precomposto L40.  
PASSEPARTOUT S with steel frame C, veneered L40.

**.02**  
PASSEPARTOUT Q acciaio C, tessuto 473.  
PASSEPARTOUT Q with steel frame C, fabric 473.

**.03**  
PASSEPARTOUT S acciaio C, restylon R04, R05, R08.  
PASSEPARTOUT S with steel frame C, restylon R04,  
R05, R08.



T



S



Q

#### Passpartout

Sedia con struttura in acciaio cromato o verniciato. Scocca in Restylon, imbottita, cuoio o impiallacciato.  
- Chair with chrome or painted steel structure. Shell in Restylon, upholstered, hide or veneered. - Chaise  
avec structure en acier chromé ou laqué. Assise en Restylon, revêtue, cuir ou laqué. - Stuhl mit

verchromt oder lackiert Stahl Struktur. Schale aus Restylon, gepolsterte, Kernleder oder Holz furniert. -  
Silla con estructura en acero cromado o barnizado. Carcasa en Restylon, tapizada, cuero o contrachapada.  
- Стул с основанием в хромированной стали. Каркас из Restylon, обитый, в коже или шпоне.

#### Struttura - Frame - Structure - Gestell - Estructura - Структура

Acciaio - Steel - Acier - Stahl - Acero - Сталь

**Y**  
Bianco - White

**R**  
Alluminio - Aluminium

**C**  
Cromo - Chrome

#### Scocca - Shell - Assise - Schale - Carcasa - Сидение И Спинка

##### S-CU, Q-CU, T-CU

Cuoio - Hide - Cuir - Kernleder - Cuero -  
Натуральная Кожа

Cuoio rigenerato - Rogenerated hide - Synderme -  
Rigeneriertes leder - Cuero regenerado - Регенерированная  
Кожа

##### S-TS, Q-TS, T-TS

Pelle - Leather - Peau - Leder - Piel - Натуральная кожа

Ecopelle - Ecoleather - Similicuir - Kunstleder - Escopiel -  
Искусственная Кожа

Tessuto - Fabric - Tissu - Stoff - Tejido - Ткань

##### S-LG, Q-LG, T-LG

Legni - Wood - Bois - Holz - Madera - Дерево

**L40**  
Rovere naturale - Natural Oak

**L26**  
Rovere moro - Dark Oak

##### S-R, Q-R, T-R

Restylon - Restylon - Restylon - Restylon - Restylon -  
Пластика Restylon

Vedi campionario per scegliere il colore - Check the  
swatches for colours - Voir l'échantillon pour choisir la  
couleur - Siehe Musterkarte um die Farbe zu wählen -  
Смотреть образцы для выбора цвета

#### Dimensioni - Dimensions - Dimensions - Abmessung - Dimensiones - Размеры

##### Passpartout S, Q

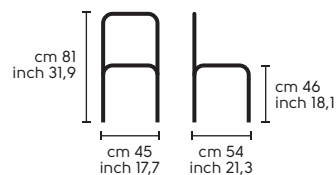

##### Passpartout T

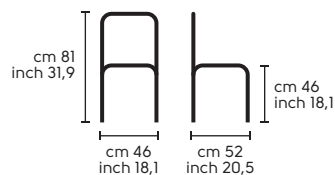

Design  
Midj R&D

# Giudecca





.01

GIUDECCA S legno L05, cuoio rigenerato Z02.

POKER 160x90 tavolo fisso acciaio Y, piano melaminico M01.

GIUDECCA S wood L05, regenerated hide Z02.

POKER 160x90 fix table with steel structure Y, melamine top M01.



S



H65, H75

#### Giudecca

Sedia e sgabello con struttura in legno di diverse finiture. Sedile in cuoio o paglia. - Chair and stool with wooden frame. Seat in hide or straw. - Chaise et tabouret en bois en différentes finitions. Assise en cuir or paille. - Stuhl und Hocker mit Holz Gestell. Sitz aus Kernleder oder Stroh. - Silla y taburete con estructura

en madera en diversos acabados. Asiento en cuero o paja. - Стул и барный стул с основанием в разных отделках дерева. Сиденье в коже или соломе.

#### Struttura - Frame - Structure - Gestell - Estructura - Структура

Legno - Wood - Bois - Holz - Madera - Дерево

**L26**  
Rovere moro - Dark Oak

**L40**  
Rovere naturale - Natural Oak

Laccato - Painted - Laqué - Lackiert - Lacado - Лак

#### Seduta e schienale - Seat and back - Assise et dossier - Sitz Und Lehne - Asiento y respaldo - сидение и спинка

##### S-CU, h75-CU

Cuoio - Hide - Cuir - Kernleder - Cuero - Натуральная Кожа

Cuoio rigenerato - Rogenerated hide - Synderme - Rigeneriertes leder - Cuero regenerado - Регенерированная Кожа

##### S-PA, h75-PA

Paglia - Straw - Paille - Stroh - Enea - Солома

Vedi campionario per scegliere il colore - Check the swatches for colours - Voir l'échantillon pour choisir la couleur - Siehe Musterkarte um die Farbe zu wählen - Смотреть образцы для выбора цвета

#### Giudecca S

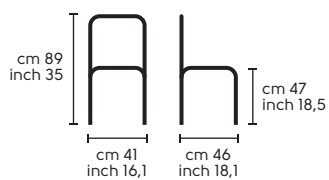

#### Giudecca H75

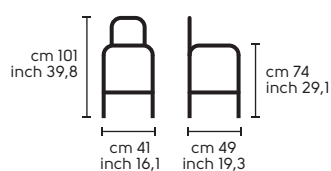

Design  
Midj R&D  
City



**.01**

CITY X acciaio Y, polipropilene P05,  
BREAK/3 basamento bistrot Y, piano LS5.

CITY X with steel frame Y, polypropylene P05,  
BREAK/3 basamento bistrot Y, top in HPL LS5.





**City**

Sedia e poltrona con struttura in acciaio cromato o verniciato. Scocca in polipropilene. - Chair and armchair with chrome or painted steel frame. Polypropylene shell. - Chaise et fauteuil avec structure en acier chromé or laqué. Assise en polipropylène. - Stuhl und Armstuhl mit verchromt oder lackiert

Stahl Struktur. Schale aus Polypropylen. - Silla y sillón con estructura en acero cromado o barnizado. Carcasa en polipropileno. - Стул или кресло с основанием в хромированной или крашенной стали. Каркас в полипропилене.

**Struttura - Frame - Structure - Gestell - Estructura - Структура**

Acciaio - Steel - Acier - Stahl - Acero

-  **Y**  
Bianco - White
-  **R**  
Alluminio - Aluminium
-  **C**  
Cromo - Chrome

**Scocca - Shell - Assise - Schale - Carcasa - Сидение И Спинка**

Polipropilene - Polypropylene - Polypropylene - Polypropylene  
- Polipropileno - Полипропилен

-  **P05**  
Bianco - White
-  **P02**  
Grigio - Grey
-  **P04**  
Nero - Black
-  **P08**  
Rosso - Red
-  **P18**  
Verde - Green
-  **P27**  
Lilla - Lilac

**Dimensioni - Dimensions - Dimensions - Abmessung - Dimensiones - Размеры**

**City X, S**

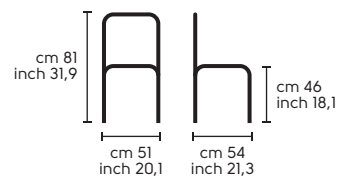

**City P**

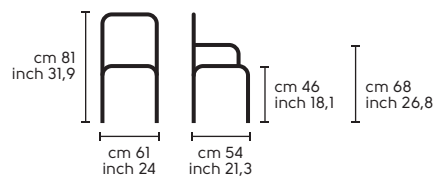

Design  
Nathalie Santin  
Nuda

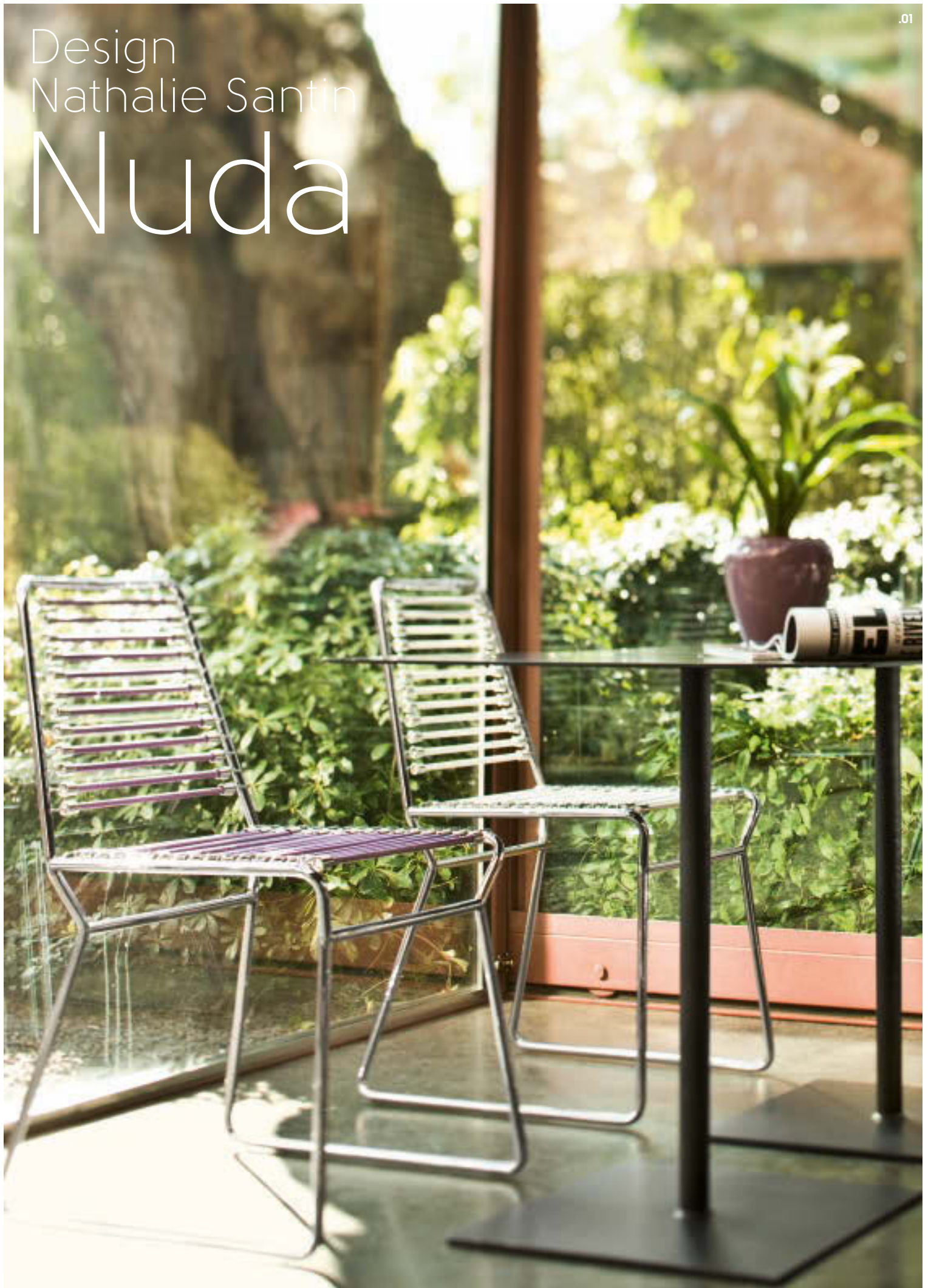

**.01**  
 NUDA S-MO acciaio C, elastico EL7.  
 NUDA S-MO with steel frame C, elastic EL7.



S



H65, H75

**Nuda**

Sedia e sgabello con struttura in metallo cromato. Sedile e schienale in rete, molle elastiche o cuoio.  
 - Chair and stool with chrome steel frame. Seat and back in mesh, hide or elastic.  
 - Chaise et tabouret avec structure en acier chromé. Assise et dossier en résille, élastique ou cuir.  
 - Stuhl und Hocker mit verchromt Stahl Struktur. Sitz und Lehne aus Netz, Kernleder oder Gummiband.  
 - Silla y taburete con

estructura en metal cromado. Asiento y respaldo en malla, muelles elasticos o cuero.  
 - Стул и барный стул с основанием в хромированном металле. Сиденье и спинка выполнены из сетки, эластичных пружин или обшиты полутвердой кожей (cuoio).

**Struttura - Frame - Structure - Gestell - Estructura - Структура**

Acciaio - Steel - Acier - Stahl - Acero - Сталь



**C**  
 Cromo - Chrome

**Seduta e schienale - Seat and back - Assise et dossier - Sitz Und Lehne - Asiento y respaldo - сидение и спинка**

**S-CU, H65-CU, H75-CU**

Cuoio - Hide - Cuir - Kernleder - Cuero - Натуральная Кожа

**S-MO, H65-MO, H75-MO**

Elastico - Elastic - élastique - elastic - elástico - резинка

**S-RE, H65-RE, H75-RE**

Rete - Mesh - Filet - Netz - Malla - Сетка

Vedi campionario per scegliere il colore - Check the swatches for colours - Voir l'échantillon pour choisir la couleur - Siehe Musterkarte um die Farbe zu wählen - Смотреть образцы для выбора цвета

**Dimensioni - Dimensions - Dimensions - Abmessung - Dimensiones - Размеры**

**Nuda S-CU, S-MO, S-RE**

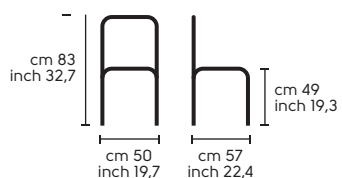

**Nuda H65-CU, H65-MO, H65-RE**

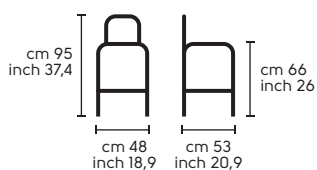

**Nuda H75-CU, H75-MO, H75-RE**

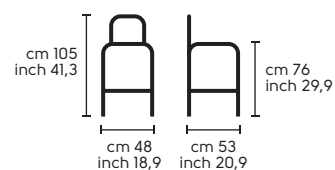

Design  
Midj R&D

# MISS





**.01**  
 MISS rivestita cuoio U05.  
 MISS fully upholstered hide U05.

**Miss**  
 Sedia con struttura in acciaio rivestita. - Chair with steel frame fully upholstered. - Chaise avec structure en acier revêtu. - Stuhl aus Stahl Struktur, völlig gepolsterte. - Silla con estructura en acero en cuero. - Стул с основанием из стали, обитый или обшитый полутвердой кожей (сuoio).

**Struttura, seduta e schienale**  
**Structure, seat and back - Structure, assise et dossier -**  
**Gestell, Sitz Und Lehne - Каркас, Сидение И Спинка**

Cuoio - Hide - Cuir - Kernleder - Cuero - Натуральная Кожа

Cuoio rigenerato - Regenerated hide - Cuir régénéré -  
 Rigeneriertes leder - Cuero regenerado - Регенерированная  
 Кожа

Vedi campionario per scegliere il colore - Check the  
 swatches for colours - Voir l'échantillon pour choisir la  
 couleur - Siehe Musterkarte um die Farbe zu wählen -  
 Смотреть образцы для выбора цвета

**Dimensioni - Dimensions - Abmessung - Dimensiones - Размеры**

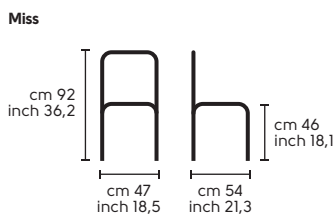

Design  
Midj R&D

# Flina





.01

FLINA S rivestita cuoio U66.

FLINA S upholstered hide U66.



S



H65, H75

**Flina - Flona**

Sedia con struttura in acciaio rivestito. - Chair with steel frame fully upholstered. - Chaise avec structure en acier revêtu ou cuir. - Stuhl aus Stahl Struktur, vollig gepolsterte. - Silla con estructura en

acero tapizada o en cuero. - Стул с основанием из стали, обитый или обшитый полутвердой кожей (cuoio).

**Struttura, seduta e schienale - Structure, seat and back  
- Structure, assise et dossier - Gestell, Sitz Und Lehne -  
Каркас, Сидение И Спинка**

Cuoio - Hide - Cuir - Kernleder - Cuero - Натуральная Кожа

Cuoio rigenerato - Regenerated hide - Cuir régénéré -  
Rigeneriertes leder - Cuero regenerado - Регенерированная  
Кожа

Vedi campionario per scegliere il colore - Check the  
swatches for colours - Voir l'échantillon pour choisir la  
couleur - Siehe Musterkarte um die Farbe zu wählen -  
Смотреть образцы для выбора цвета

**Dimensioni - Dimensions - Dimensions - Abmessung - Dimensiones - Размеры**

**Flina S**

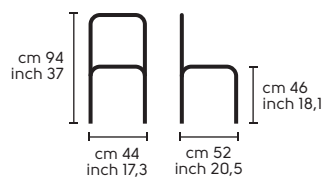

**Flona H65-R**

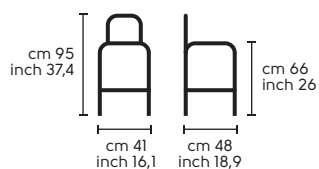

**Flona H75-R**

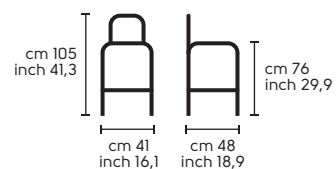

Design  
Midj R&D

# Silvy TS











**.01**  
SILVY TS S-BR ecopelle 724, SILVY TS S-AR ecopelle 722, SILVY TS S-A acciaio C, ecopelle 722, SILVY TS H65 acciaio C, ecopelle 735, SILVY TS H75 acciaio C, ecopelle 735.  
SILVY TS S-BR ecoleather 724, SILVY TS S-AR ecoleather 722, SILVY TS S-A with steel frame C, ecoleather 722, SILVY TS H65 with steel frame C, ecoleather 735, SILVY TS H75 with steel frame C, ecoleather 735.

**.02**  
SILVY TS S-A acciaio Y, tessuto 378, COMPOSIT/2 basamento bistrot acciaio Y, piano HPL LS5.  
SILVY TS S-A with steel frame Y, fabric 378, COMPOSIT/2 bistro base in steel Y, top HPL LS5.

**.03**  
SILVY TS H65 acciaio C, ecopelle 368.  
SILVY TS H65 with steel frame C, ecoleather 368.



#### Silvy TS

Sedia, poltrona, sgabello con struttura in acciaio cromato, verniciato o rivestito. Seduta imbottita. - Chair, armchair, stool with chrome, painted or upholstered steel frame. Upholstered shell. - Chaise, fauteuil et tabouret avec structure en acier chromé, laqué ou revêtu. Assise revêtu. - Stuhl, Armstuhl

und Hocker mit lackiert oder lackiertes Stahl Struktur. Gepolsterte Schale. - Silla, sillón, taburete con estructura en acero cromado, barnizado o tapizado. Asiento tapizado. - Стул, кресло, барный стул с основанием с хромированной или крашенной стали или обшитым. Сиденье обитое.

#### Struttura - Frame - Structure - Gestell - Estructura - Структура

##### SB-TS, SA-TS, PB-TS, H65-TS, H75-TS

Acciaio - Steel - Acier - Stahl - Acero - Сталь



**Y**  
Bianco - White



**R**  
Alluminio - Aluminium



**C**  
Cromo - Chrome

#### Seduta e schienale - Seat and back - Assise et dossier - Sitz Und Lehne - Asiento y respaldo - сидение и спинка

##### SB-TS, SA-TS, PB-TS, H65-TS, H75-TS

Pelle - Leather - Peau - Leder - Piel - Натуральная кожа

Ecopelle - Ecoleather - Similicuir - Kunstleder - Escopiel - Искусственная Кожа

Tessuto - Fabric - Tissu - Stoff - Tejido - Ткань

Vedi campionario per scegliere il colore - Check the swatches for colours - Voir l'échantillon pour choisir la couleur - Siehe Musterkarte um die Farbe zu wählen - Смотреть образцы для выбора цвета

#### Struttura, seduta e schienale - Structure, seat and back Structure, assise et dossier - Gestell, Sitz Und Lehne - Каркас, Сидение И Спинка

##### SBR-CU, SAR-CU, PBR-CU

Pelle - Leather - Peau - Leder - Piel - Натуральная кожа

Ecopelle - Ecoleather - Similicuir - Kunstleder - Escopiel - Искусственная Кожа

Tessuto - Fabric - Tissu - Stoff - Tejido - Ткань

Vedi campionario per scegliere il colore - Check the swatches for colours - Voir l'échantillon pour choisir la couleur - Siehe Musterkarte um die Farbe zu wählen - Смотреть образцы для выбора цвета

#### Dimensioni - Dimensions - Dimensions - Abmessung - Dimensiones - Размеры

##### Silvy SB-TS, SBR-TS

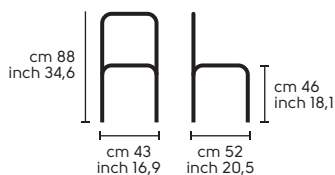

##### Silvy SA-TS, SAR-TS

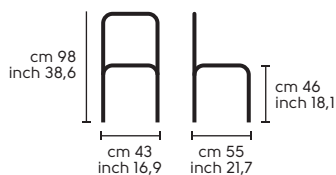

##### Silvy PB-TS, PBR-TS

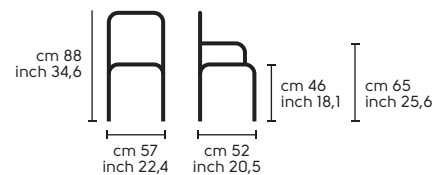

##### Silvy H65-TS

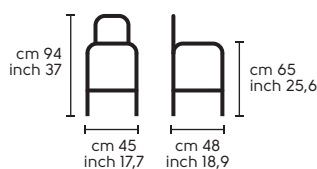

##### Silvy H75-TS

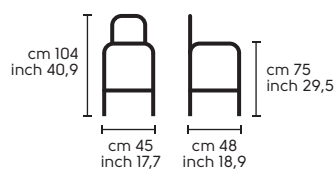

Design  
Midj R&D

# Silvy CU









**.01**

SILVY CU S-BR cuoio rigenerato Z42, SILVY CU S-B acciaio C, cuoio rigenerato Z22, SILVY S-AR cuoio rigenerato Z18, SILVY CU P-B acciaio C, cuoio rigenerato Z42, SILVY CU P-BR acciaio C, cuoio rigenerato Z42, SILVY CU H65 acciaio Y, cuoio rigenerato Z18, SILVY CU H75 acciaio Y, cuoio rigenerato Z18.

SILVY CU S-BR regenerated hide Z42, SILVY CU S-B with steel frame C, regenerated hide Z22, SILVY S-AR regenerated hide Z18, SILVY CU P-B with steel frame C, regenerated hide Z42, SILVY CU P-BR with steel frame C, regenerated hide Z42, SILVY CU H65 with steel frame Y, regenerated hide Z18, SILVY CU H75 with steel frame Y, regenerated hide Z18.

**.02**

SILVY CU P-B acciaio Y, cuoio rigenerato Z42, SILVY CU P-BR cuoio rigenerato Z42.

SILVY CU P-B with steel frame Y, regenerated hide Z42, SILVY CU P-BR regenerated hide Z42.

**Silvy CU**

Sedia, poltrona, sgabello con struttura in acciaio cromato, verniciato o rivestito. Seduta rivestita. Chair, armchair, stool and lounge chair with chrome, painted or upholstered steel frame. Hide shell. - Chaise, fauteuil, tabouret avec structure en acier chromé, laqué ou revêtue. Assise revêtue. - Stuhl, Armstuhl, Hocker und Lounge Stuhl mit verchromt, lackiert oder gepolstertes Stahl Struktur. Schale

aus Kernleder. - Silla, sillón, taburete con estructura en acero cromado, barnizado o tapizado. Asiento en cuero. - Стул, кресло, барный стул с основанием с хромированной или крашенной стали или обшитым. Сиденье обшито твердой кожей (cuoio).

**Struttura - Frame - Structure - Gestell - Estructura - Структура****SB-CU, SA-CU, PB-CU, H65-CU, H75-CU**

Acciaio - Steel - Acier - Stahl - Acero - Сталь

**Y**  
Bianco - White

**R**  
Alluminio - Aluminium

**C**  
Cromo - Chrome

**Seduta e schienale - Seat and back - Assise et dossier - Sitz Und Lehne - Asiento y respaldo - сидение и спинка****SB-CU, SA-CU, PB-CU, H65-CU, H75-CU**

Cuoio - Hide - Cuir - Kernleder - Cuero - Натуральная Кожа

Cuoio rigenerato - Regenerated hide - Cuir régénéré - Rigeneriertes leder - Cuero regenerado - Регенерированная Кожа

Vedi campionario per scegliere il colore - Check the swatches for colours - Voir l'échantillon pour choisir la couleur - Siehe Musterkarte um die Farbe zu wählen - Смотреть образцы для выбора цвета

**Struttura, seduta e schienale - Structure, seat and back Structure, assise et dossier - Gestell, Sitz Und Lehne - Каркас, Сидение И Спинка****SBR-CU, SAR-CU, PBR-CU**

Cuoio - Hide - Cuir - Kernleder - Cuero - Натуральная Кожа

Cuoio rigenerato - Regenerated hide - Cuir régénéré - Rigeneriertes leder - Cuero regenerado - Регенерированная Кожа

Vedi campionario per scegliere il colore - Check the swatches for colours - Voir l'échantillon pour choisir la couleur - Siehe Musterkarte um die Farbe zu wählen - Смотреть образцы для выбора цвета

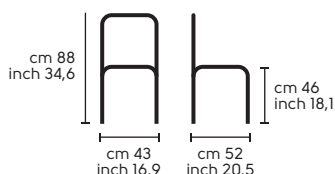
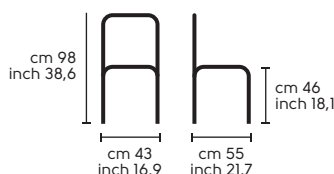
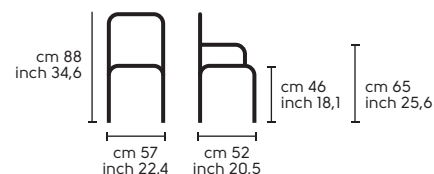
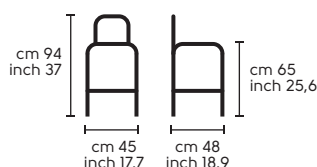
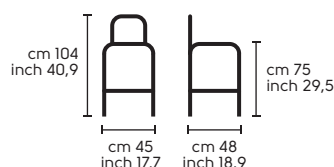
**Dimensioni - Dimensions - Dimensions - Abmessung - Dimensiones - Размеры****Silvy SB-CU, SBR-CU****Silvy SA-CU, SAR-CU****Silvy PB-CU, PBR-CU****Silvy H65-CU****Silvy H75-CU**

Design  
Area 44

# Soffio





**.01 .02**  
SOFFIO TS completamente rivestita tessuto 457,  
ARMANDO tavolo fisso 80x80 in acciaio Y.  
SOFFIO TS fully upholstered fabric 457,  
ARMANDO fix table 80x80 with steel frame Y.



.03  
SOFFIO CU rivestita cuoio U05.  
SOFFIO CU upholstered hide U05.



**Soffio**

Sedia con struttura in acciaio completamente imbottita. - Chair with steel frame fully upholstered. - Chaise avec structure en acier complètement revêtue. - Stuhl aus Stahl Struktur, völlig gepolsterte.

Silla con estructura en acero completamente tapizado. - Стул с основанием из стали, полностью обитый.

**Scocca - Shell - Assise - Schale - Carcasa - Сидение И Спинка**

**CU**

Cuoio - Hide - Cuir - Kernleder - Cuero - Натуральная Кожа

Cuoio rigenerato - Rogenerated hide - Cuir régénéré - Rigeneriertes leder - Cuero regenerado - Регенерированная Кожа

**TS**

Pelle - Leather - Peau - Leder- Piel - Натуральная кожа

Ecopelle - Ecoleather - Similicuir - Kunstleder - Escopiel - Искусственная Кожа

Tessuto - Fabric - Tissu - Stoff - Tejido - Ткань

Vedi campionario per scegliere il colore - Check the swatches for colours - Voir l'échantillon pour choisir la couleur - Siehe Musterkarte um die Farbe zu wählen - Смотреть образцы для выбора цвета

**Dimensioni - Dimensions - Dimensjons - Abmessung - Dimensiones - Размеры**

**Soffio**

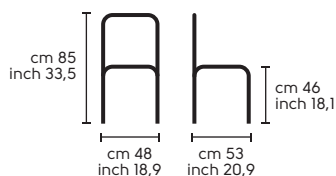

Design  
Midj R&D

# King





**.01**  
KING rivestita ecopelle 726.  
KING upholstered ecoleather 726



**King**  
Sedia con struttura in acciaio imbottito. - Chair with steel frame fully upholstered. - Chaise avec structure en acier revêtu. - Stuhl aus Stahl Struktur, völlig gepolsterte. - Silla con estructura en acero tapizada. - Стул с основанием из стали, обитый или обшитый полутвердой кожей.

**Struttura, seduta e schienale**  
**Structure, seat and back - Structure, assise et dossier -**  
**Gestell, Sitz Und Lehne - Каркас, Сидение И Спинка**

**King**  
Pelle - Leather - Peau - Leder- Piel - Натуральная кожа

Ecopelle - Ecoleather - Similicuir - Kunstleder - Ecopiel -  
Искусственная Кожа

Tessuto - Fabric - Tissu - Stoff - Tejido- Ткань

Vedi campionario per scegliere il colore - Check the swatches for colours - Voir l'échantillon pour choisir la couleur - Siehe Musterkarte um die Farbe zu wählen - Смотреть образцы для выбора цвета

**Dimensioni - Dimensions - Dimensions - Abmessung - Dimensiones - Размеры**

**King**

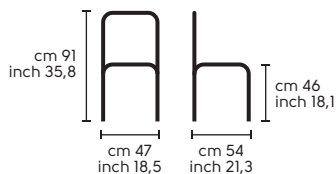

Design  
StudioKappa  
Sharon







**.01**  
SHARON rivestita tessuto 369,  
COMPOSIT 3 tavolo bostrot in acciaio F, piano HPL LS4 .  
SHARON upholstered fabric 369,  
COMPOSIT 3 bistrot table with steel frame F, top HPL LS4.

**.02**  
SHARON rivestita ecopelle 736.  
SHARON upholstered ecoleather 736.



#### Sharon

Sedia con struttura in acciaio imbottita. - Chair with steel frame fully upholstered. - Chaise avec structure en acier revêtue. - Stuhl aus Stahl Struktur, völlig gepolsterte. - Silla con estructura en acero tapizado. - Стул с основанием из стали, полностью обитый.

#### Struttura, seduta e schienale - Structure, seat and back - Structure, assise et dossier - Gestell, Sitz Und Lehne - Каркас, Сидение И Спинка

Pelle - Leather - Peau - Leder - Piel - Натуральная кожа

Ecopelle - Ecoleather - Similicuir - Kunstleder - Ecopiel -  
Искусственная Кожа

Tessuto - Fabric - Tissu - Stoff - Tejido - Ткань

Vedi campionario per scegliere il colore - Check the swatches for colours - Voir l'échantillon pour choisir la couleur - Siehe Musterkarte um die Farbe zu wählen - Смотреть образцы для выбора цвета

#### Dimensioni - Dimensions - Dimensions - Abmessung - Dimensiones - Размеры

##### Sharon

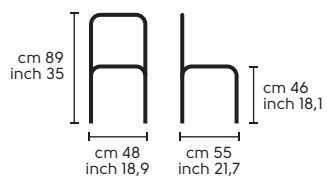

Design  
StudioKappa

# Elettra



.01

ELETTRA rivestita ecopelle 722.

ELETTRA upholstered ecoleather 722.



#### Elettra

Sedia con struttura in acciaio imbottita. - Chair with steel frame upholstered. - Chaise avec structure en acier complètement revêtue. - Stuhl aus Stahl Struktur, völlig gepolsterte. - Silla con estructura en acero completamente tapizado. - Стул с основанием из стали, полностью обитый.

#### Struttura, seduta e schienale - Structure, seat and back - Structure, assise et dossier - Gestell, Sitz Und Lehne - Каркас, Сидение И Спинка

Pelle - Leather - Peau - Leder - Piel - Натуральная кожа

Ecopelle - Ecoleather - Similicuir - Kunstleder - Ecopiel -  
Искусственная Кожа

Tessuto - Fabric - Tissu - Stoff - Tejido - Ткань

Vedi campionario per scegliere il colore - Check the swatches for colours - Voir l'échantillon pour choisir la couleur - Siehe Musterkarte um die Farbe zu wählen - Смотреть образцы для выбора цвета

#### Dimensioni - Dimensions - Dimensions - Abmessung - Dimensiones - Размеры

##### Elettra

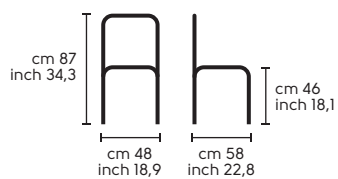

Design  
sempere#poli

# Guapa







**.01**  
GUAPA S verniciato bianco Y, cuoio TK verde salvia U69.  
GUAPA S white painted Y, hide TK verde salvia U69.

**.02**  
GUAPA S verniciato bianco Y, cuoio TK verde salvia U69, azzurro U66.  
Tavolo INFINITY ø 1000 verniciato bianco Y, vetro bianco lucido extra chiaro VE5.  
GUAPA S white painted Y, hide TK verde salvia U69, azzurro U66.  
INFINITY table ø 1000 white painted Y, extra clear glossy white glasstop VE5.



**.03**  
GUAPA DN verniciato bianco Y, cuoio TK verde salvia U69, azzurro U66.  
GUAPA DN white painted Y, hide TK verde salvia U69, azzurro U66.

**.04**  
GUAPA AT verniciato bianco Y, cuoio TK azzurro U66, verde salvia U69.  
GUAPA AT white painted Y, hide TK azzurro U66, verde salvia U69 .







**.05**  
GUAPA h65 / h75 cromato C, cuoio TK  
azzurro U66, blu oceano U67.  
GUAPA h67 / h75 chrome C, hide TK  
azzurro U66, blu oceano U67.

**.06**  
GUAPA S cromato C, cuoio TK verde salvia U69.  
GUAPA S chrome C, hide TK verde salvia U69.



**.07**  
GUAPA AT verniciato bianco Y, cuoio TK  
azzurro U66, blu oceano U67.  
GUAPA CT-L, CT-M, CT-S verniciato bianco Y,  
cuoio bianco U05.  
GUAPA AT white painted Y, hide TK azzurro  
U66, blu oceano U67.  
GUAPA CT-L, CT-M, CT-S white painted Y,  
white hide U05.



#### Guapa S, S4, P, P4, AT, AT4, DN, H65, H75

Sedia, poltrona, attesa, sgabello e dondolo con struttura in acciaio cromato, nichel nero o verniciato. Seduta in cuoio spessorato. - Chair, armchair, lounge chair, stool and rocking chair with chrome or painted steel or black nickel frame. Thicker hide seat. - Chaise, fauteuil, attente, tabouret et rocking chair avec structure en acier chromé ou laqué, nickel noir. Assise en cuir TK. - Stuhl, Armstuhl, Lounge Stuhl, Hocker, und Schaukelstuhl mit verchromt oder lackiert Stahl struktur, oder Schwarz Nickel Struktur. Schale aus dicker Kernleder. - Silla, sillón, espera, taburete y balancín con estructura en acero cromado, níquel negro o barnizado. Asiento en cuero spessorato. - Стул, кресло, лаунж-кресло, барный стул и кресло-качалка с основанием в хромированной стали, черном никеле или крашенное. Сиденье в утолщенной коже.

#### Guapa CT-S, CT-M, CT-L

Coffee table con struttura in acciaio cromato o verniciato. Top rivestito in cuoio. - Coffee table with chrome or painted frame. Upholstered top in hide. - Table basse avec structure en acier chromé ou laqué. Plateau revêtu en cuir. - Couchtisch mit verchromt oder lackiert Stahl Struktur. Platte aus Kernleder. - Mesa café con estructura en acero cromado o barnizado. Sobre en cuero. - Кофейный столик с основанием в хромированной или крашенной стали. Столешница обита кожей.

#### Struttura - Frame - Structure - Gestell - Estructura - Структура

Acciaio - Steel - Acier - Stahl - Acero - Сталь



**C**  
Cromo - Chrome



**Z**  
Nichel nero - Black nickel



**Y**  
Bianco - White

#### Seduta e schienale - Seat and back - Assise et dossier - Sitz Und Lehne - Asiento y respaldo - сидение и спинка

Cuoio - Hide - Cuir - Kernleder - Cuero -  
Натуральная Кожа

Vedi campionario per scegliere il colore - Check the swatches for colours - Voir l'échantillon pour choisir la couleur - Siehe Musterkarte um die Farbe zu wählen - Смотреть образцы для выбора цвета

#### Dimensioni - Dimensions - Dimensions - Abmessung - Dimensiones - Размеры

##### Guapa S, S4

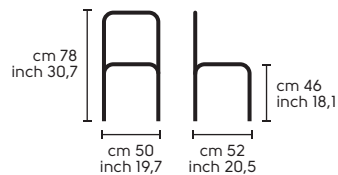

##### Guapa P, P4

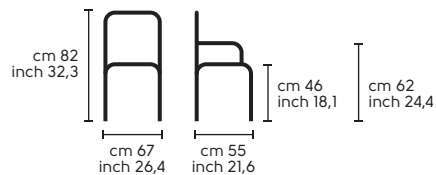

##### Guapa AT, AT4

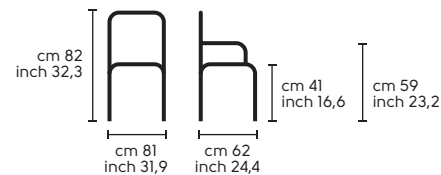

##### Guapa H65

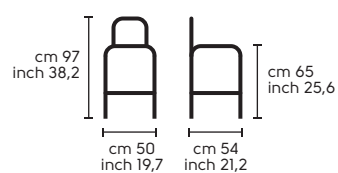

##### Guapa H75

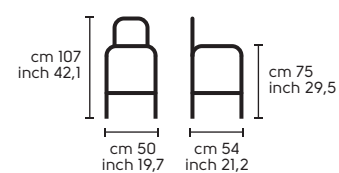

##### Guapa DN

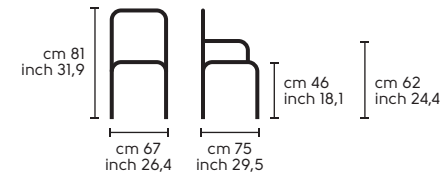

Design  
Beatriz Sempere  
Apelle







**.01**

APELLE P oro rosa, cuoio rosa cipria U64.

APELLE P pink gold, hide rosa cipria U64.

**.02 .03 .04**

APELLE S verniciato bianco Y, cuoio arancio U21, giallo ocra U22, bianco U05.

Tavolo ARMANDO 2900x1000 verniciato bianco Y.

APELLE S white painted Y, hide arancio U21, giallo ocra U22, white U05.

ARMANDO table 2900x1000 white painted Y.



.02











**.05**  
APELLE AT cromato C, cuoio blu oceano U67.  
APELLE AT chrome C, hide blu oceano U67.

**.06**  
APELLE h65 verniciato bianco Y, cuoio  
bianco U05.  
APELLE h65 white painted Y, hide white U05.

**.07**  
APELLE AT LG cromato C, noce fiammato L24.  
APELLE AT LG chrome C, flamed walnut L24.









#### Apelle S, P, H65, H75, POUF, CT

Sedia, poltrona, pouf, sgabello e coffee table con struttura in acciaio cromato, nichel nero, oro rosa o verniciato. Seduta in cuoio. - Chair, armchair, lounge chair, stool and rocking chair with chrome or painted steel, black nickel, pink gold frame. Hide shell. - Chaise, fauteuil, pouf, tabouret et table basse avec structure en acier chromé ou laqué, nickel noir, or rosé. Assise en cuir. - Stuhl, Armstuhl, Lounge Stuhl, Hocker, und Schaukelstuhl mit verchromt oder lackiert Stahl struktur, Schwarz Nickel oder Pink Gold Struktur. Schale aus dicker Kernleder. - Silla, sillón, pouf, taburete y mesa café con estructura en acero cromado, níquel negro, oro rosa o barnizado. Asiento en cuero. - Стул, кресло, пуф, барный стул и кофейный столик с основанием в хромированной стали, черном никеле, отделке "розовое золото" или крашенным. Сиденье обшито полутвердой кожей (cuoio).

#### Apelle DN, AT

Attesa e dondolo con struttura in acciaio cromato, nichel nero o verniciato. Scocca in cuoio. - Lounge chair and rocking chair with chrome or painted, black nickel frame. Hide shell. - Accueil et rocking chair avec structure en acier chromé, nickel noir ou laqué. Assise en cuir. - Lounge Stuhl und Schaukelstuhl mit verchromt oder lackiert Stahl Struktur, Schwarz Nickel Struktur. Schale aus Kernleder. Espera y balancín con estructura en acero cromado, níquel negro o barnizado. Asiento en cuero. - Лаунж-кресло и кресло-качалка с основанием в хромированной стали, черном никеле или крашенным. Каркас обшитый полутвердой кожей (cuoio).

#### Apelle AT LG

Attesa con struttura in acciaio cromato, nichel nero o verniciato. Scocca in impiallacciato finitura noce fiammato. - Lounge chair with chrome or painted, black nickel frame. Upholstered hide top. - Accueil avec structure en acier chromé ou laqué, nickel noir. Assise en plaqué. - Lounge Stuhl mit verchromt oder lackiert Stahl Struktur, Schwarz Nickel Struktur. Platte aus Kernleder. - Sillón con estructura en acero cromado, níquel negro o barnizado. Asiento contrachapado en poqual vaporizado. - Лаунж-кресло с основанием в хромированной стали, черном никеле или крашенным. Каркас в шпоне цвета орех "посе

#### Struttura - Frame - Structure - Gestell - Estructura - Структура

##### S, P, H65, H75

Acciaio - Steel - Acier - Stahl - Acero - Сталь



#### Struttura - Frame - Structure - Gestell - Estructura - Структура

##### AT, DN, POUF

Acciaio - Steel - Acier - Stahl - Acero - Сталь

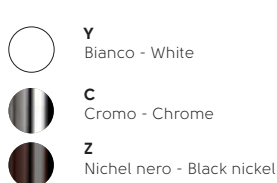

#### Seduta e schienale - Seat and back - Assise et dossier - Sitz Und Lehne - Asiento y respaldo - сидение и спинка

##### S, P, H65, H75, AT, DN, POUF

Cuoio - Hide - Cuir - Kernleder - Cuero - Натуральная Кожа

##### AT LG

Legni - Wood - Bois - Holz - Madera - Дерево



Vedi campionario per scegliere il colore - Check the swatches for colours - Voir l'échantillon pour choisir la couleur - Siehe Musterkarte um die Farbe zu wählen - Ver muestras para elegir el color - Смотреть образцы для выбора цвета

#### Dimensioni - Dimensions - Dimensions - Abmessung - Dimensiones - Размеры

##### Apelle S

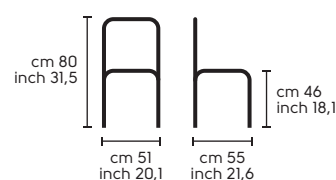

##### Apelle P

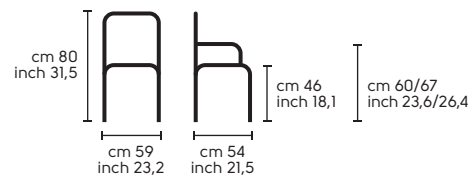

##### Apelle AT, AT-LG

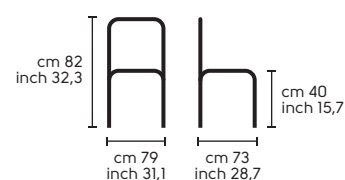

##### Apelle Pouf

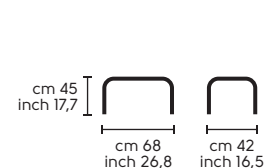

##### Apelle H65

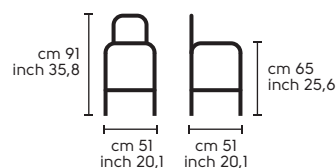

##### Apelle H75

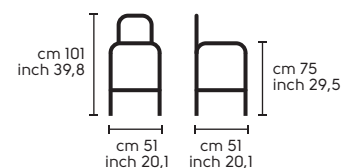

##### Apelle DN

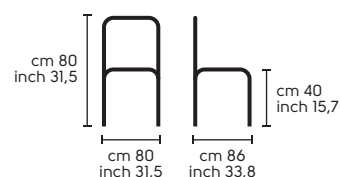

Design  
Cappellini & Licheri

# Ciak



**.01.02**

CIAK acciaio Z, cuoio U02.

CIAK with steel frame Z, hide U02.

**Ciak**

Poltrona con struttura in acciaio cromato o nichel nero. Sedile e schienale in cuoio. - Armchair with chrome steel or black nickel frame. Upholstered shell. - Fauteuil avec structure en acier chromé ou nickel noir. Assise et dossier en cuir. - Armstuhl mit verchromt Stahl oder Schwarz Nickel Struktur.

Gepolsterte Schale. - Sillon con estructura en acero cromado o niquel negro. Asiento y respaldo en cuero. - Кресло с основанием в хромированной стали или черном никеле. Сиденье и спинка обшитые полутвердой кожей (cuoio).

**Struttura - Frame - Structure - Gestell - Estructura - Структура**

Acciaio - Steel - Acier - Stahl - Acero - Сталь

**C**  
Cromo - Chrome**Z**  
Nichel nero - Black nickel**Seduta e schienale - Seat and back - Assise et dossier - Sitz Und Lehne - Asiento y respaldo - сидение и спинка**

Cuoio - Hide - Cuir - Kernleder - Cuero - Натуральная Кожа

Vedi campionario per scegliere il colore - Check the swatches for colours - Voir l'échantillon pour choisir la couleur - Siehe Musterkarte um die Farbe zu wählen - Смотреть образцы для выбора цвета

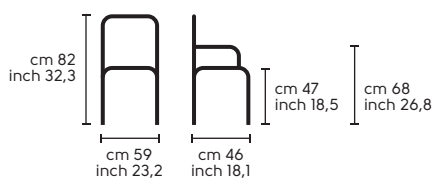
**Dimensioni - Dimensions - Dimensiones - Abmessung - Dimensiones - Размеры****Ciak**

Design  
Midj R&D  
F12







**.01**  
F12 acciaio C, ecopelle 722.  
F12 with steel frame C, ecoleather 722

**.02 .03**  
F12 acciaio C, tessuto 368.  
F12 with steel frame C, fabric 368.

**F12**

Sedia girevole con base in acciaio cromato. Seduta imbottita. - Swivel chair with chrome steel base. Upholstered seat. - Chaise pivotante en acier chrome. Assise revêtue- Drehbar Stuhl mit verchromt

Stahl Gestell. Gepolsterte Schale. - Silla giratoria con base en acero cromado. Carcasa tapizada. - Вращающийся стул с основанием в хромированной стали. Сиденье обитое.

**Struttura - Frame - Structure - Gestell - Estructura - Структура**

Acciaio - Steel - Acier - Stahl - Acero - Сталь



**C**  
Cromo - Chrome

**Scocca - Shell - Assise - Schale - Carcasa - Сидение И Спинка**

Pelle - Leather - Peau - Leder- Piel - Натуральная кожа

Ecopelle - Ecoleather - Similicuir - Kunstleder - Ecopiel - Искусственная Кожа

Tessuto - Fabric - Tissu - Stoff - Tejido- Ткань

Vedi campionario per scegliere il colore - Check the swatches for colours - Voir l'échantillon pour choisir la couleur - Siehe Musterkarte um die Farbe zu wählen - Смотреть образцы для выбора цвета

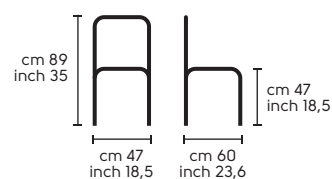
**Dimensioni - Dimensions - Dimensions - Abmessung - Dimensiones - Размеры****F12**

Design  
Cappellini & Licheri  
Portofino





**.01**  
PORTOFINO acciaio C, ecopelle 735.  
PORTOFINO with steel frame C, ecoleather 735.

**.02**  
PORTOFINO acciaio C, ecopelle 735.  
PORTOFINO with steel frame C, ecoleather 735.



**.02**



**.03**  
PORTOFINO acciaio C, ecopelle 722,  
PORTOFINO tavolo fisso in acciaio C, piano vetro V30.  
PORTOFINO with steel frame C, ecoleather 722,  
PORTOFINO fix table with steel frame C, glass top V30.

**.04**  
PORTOFINO acciaio C, ecopelle vintage VII.  
PORTOFINO with steel frame C, vintage ecoleather VII.

**Portofino**

Poltrona con struttura in acciaio cromato, nichel nero o verniciato. Seduta imbottita. - Armchair with chrome or painted steel, black nichel frame. Upholstered shell. - Fauteuil avec structure en acier chromé ou laqué, nichel noir. Assise revêtue. - Armstuhl mit verchromt oder lackiert Stahl Struktur,

Schwarz Nickel Struktur. Gepolsterte Schale. - Sillon con estructura en acero cromado, niquel negro o barnizado. Asiento tapizado. - Кресло с основанием в хромированной стали, черном никеле или крашенным. Сиденье обитое.

**Struttura - Frame - Structure - Gestell - Estructura - Структура**

Acciaio - Steel - Acier - Stahl - Acero - Сталь



**Y**  
Bianco - White



**C**  
Cromo - Chrome



**Z**  
Nichel nero - Black nickel

**Scocca - Shell - Assise - Schale - Carcasa - Сидение И Спинка**

Pelle - Leather - Peau - Leder - Piel - Натуральная кожа

Ecopelle - Ecoleather - Similicuir - Kunstleder - Escopiel - Искусственная Кожа

Tessuto - Fabric - Tissu - Stoff - Tejido - Ткань

Vedi campionario per scegliere il colore - Check the swatches for colours - Voir l'échantillon pour choisir la couleur - Siehe Musterkarte um die Farbe zu wählen - Смотреть образцы для выбора цвета

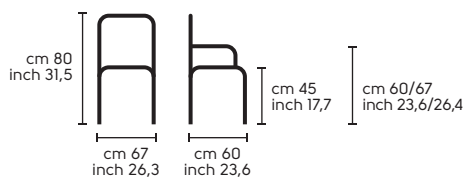
**Dimensioni - Dimensions - Dimensiones - Abmessung - Dimensiones - Размеры****Portofino**

Design  
Paolo Vernier

WWW

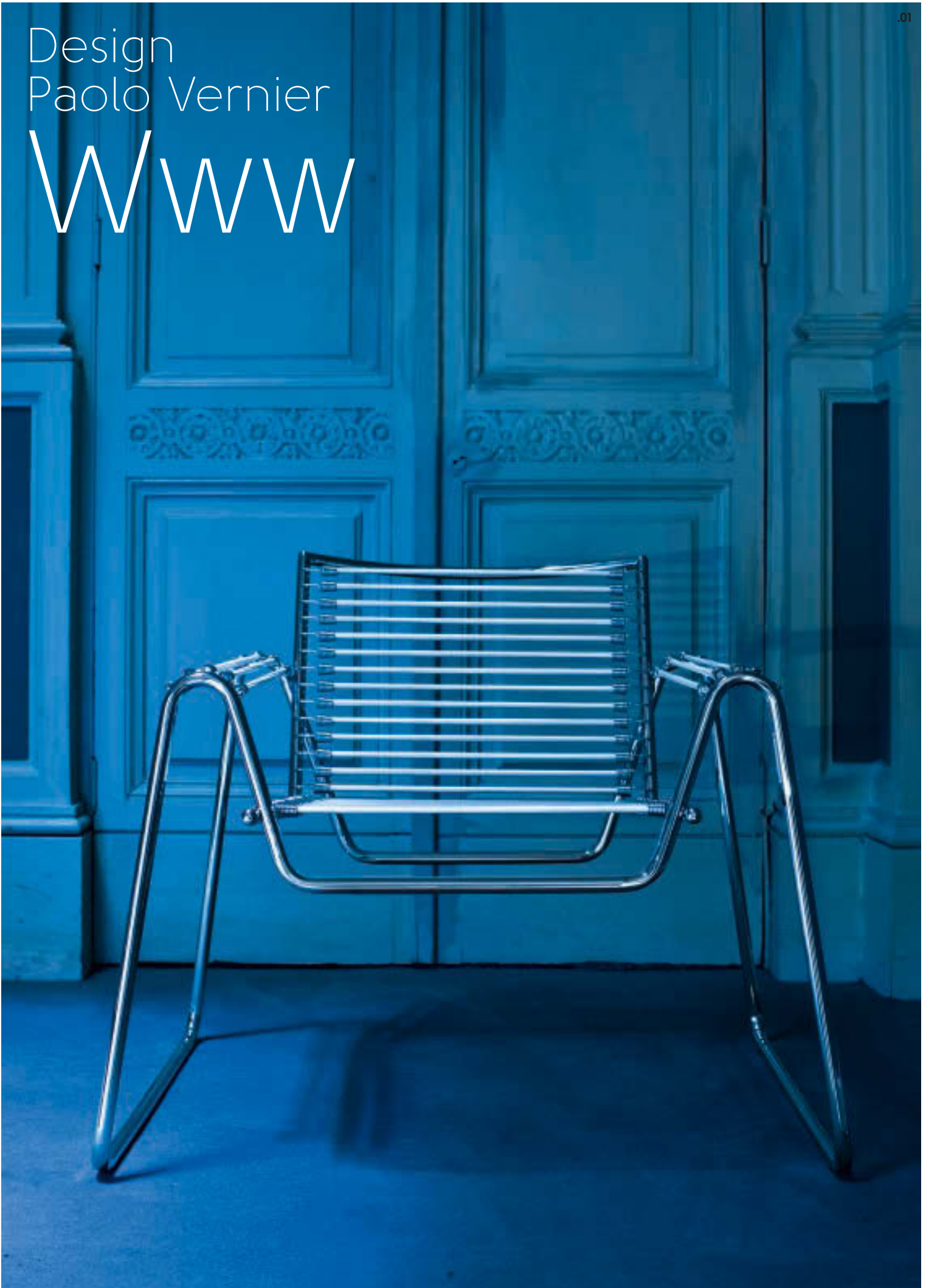

.01

WWW MO acciaio C, elastico EL3.

WWW MO with steel frame C, elastic EL3.

.02

.02

WWW CU acciaio C, cuoio H01.

WWW CU with steel frame C, hide H01



**Www**

Sedia da attesa con struttura in acciaio cromato. Seduta in cuoio o molle elastiche. - Lounge chair with chrome steel frame. Hide or elastic seat and back. - Chaise attende avec structure en acier chromé, assise en cuir et avec élastiques - Lounge Stuhl mit verchromt Stahl Struktur. Kernleder oder

GummibandSitz und Lehne. - Silla de espera con estructura en acero cromado. Asiento ec cuero o tapizado. - Лаунж-стул с основанием в хромированной стали. Сиденье обшито полутвердой кожей (сuoio) или выполнено из эластичных пружин.

**Struttura - Frame - Structure - Gestell - Estructura - Структура**

Acciaio - Steel - Acier - Stahl - Acero - Сталь



**C**  
Cromo - Chrome

**Seduta e schienale - Seat and back - Assise et dossier - Sitz Und Lehne - Asiento y respaldo - сидение и спинка**

**MO**

Elastico - Elastic - élastique - elastic - elástico - резинка

**CU**

Cuoio - Hide - Cuir - Kernleder - Cuero - Натуральная Кожа

Vedi campionario per scegliere il colore - Check the swatches for colours - Voir l'échantillon pour choisir la couleur - Siehe Musterkarte um die Farbe zu wählen - Смотреть образцы для выбора цвета

**Dimensioni - Dimensions - Dimensions - Abmessung - Dimensiones - Размеры**

**Www**

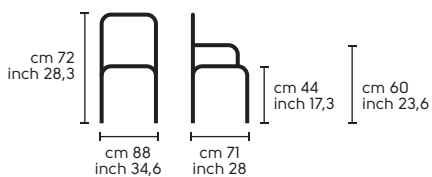

Design  
Cappellini & Licheri

# Axial



.01

AXIAL S acciaio C, ecopelle 724.  
COMPOSIT 2 tavolo bistrot in acciaio C,  
piano L40

AXIAL S with steel frame C, ecoleather  
724.  
COMPOSIT 2 bistrot table with steel  
frame C, top L40



S



T



SG



PQ

#### Axial

Poltrona fissa e girevole, sgabello con struttura in acciaio cromato. Seduta imbottita. - Fix and swivel armchair, stool with chromed steel frame. Upholstered shell. - Fauteuil fixe et pivotant avec structure en acier chromé ou laqué. Assise Revêtue. - Fest und drehbar Armstuhl, Hocker mit verchromt Stahl

Struktur. Gepolsterte Schale. - Sillon fijo y giratorio con estructura en acero cromado. Asiento tapizado. - Кресло фиксированное и вращающееся, барный стул с основанием в хромированной стали. Сиденье обитое.

#### Struttura - Frame - Structure - Gestell - Estructura - Структура

S, T

Acciaio - Steel - Acier - Stahl - Acero - Сталь



C  
Cromo - Chrome

PQ, SG

Acciaio - Steel - Acier - Stahl - Acero - Сталь



C  
Cromo - Chrome



K  
Satinato-Satin

#### Scocca - Shell - Assise - Schale - Carcasa - Сидение И Спинка

Pelle - Leather - Peau - Leder - Piel - Натуральная кожа

Ecopelle - Ecoleather - Similicuir - Kunstleder - Ecopiel - Искусственная Кожа

Tessuto - Fabric - Tissu - Stoff - Tejido - Ткань

Vedi campionario per scegliere il colore - Check the swatches for colours - Voir l'échantillon pour choisir la couleur - Siehe Musterkarte um die Farbe zu wählen - Смотреть образцы для выбора цвета

#### Dimensioni - Dimensions - Dimensions - Abmessung - Dimensiones - Размеры

Axial S, T, PQ

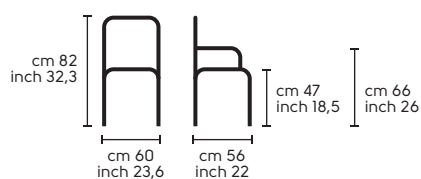

Axial SG

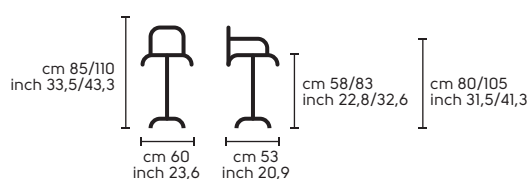

Design  
Cappellini & Licheri  
Marsiglia







**.01**  
MARSIGLIA T acciaio C, ecopelle 722.  
MARSIGLIA T with steel frame C, ecoleather 722.

**.02**  
MARSIGLIA SG acciaio C, ecopelle 730.  
MARSIGLIA SG with steel frame C, ecoleather 730.



.03  
MARSIGLIA ATT acciaio C, ecopelle 730.  
MARSIGLIA ATT with steel frame C, ecoleather 730.



S



T



PQ



SG



PA110



PA140



ATT

### Marsiglia S,T

Poltrona fissa con struttura in acciaio cromato o verniciato. Seduta imbottita. - Fix armchair with chrome or painted steel frame. Upholstered shell. - Fauteuil fixe avec structure en acier chromé ou laqué. Assise revêtue. - Fest Armstuhl mit verchromt oder lackiert Stahl Struktur. Gepolsterte Schale. - Sillon fijo con estructura en acero cromado o barnizado. Asiento tapizado. - Кресло фиксированное с основанием в хромированной или крашенной стали. Сиденье обитое.

### Marsiglia ATT, PQ, SG, PA110, PA140

Poltrona girevole, attesa, sgabello e panca con struttura in acciaio cromato. Seduta imbottita. - Swivel armchair, lounge chair, stool and bench with chrome steel frame. Upholstered shell. - Fauteuil pivotante, accueil, tabouret et banquette avec structure en acier chromé. Assise revêtue. - Drehbar Armstuhl, Lounge Stuhl und Bank mit verchromt Stahl Struktur. Gepolsterte Schale. - Sillon giratorio, espera, taburete y bancada con estructura en acero cromado. Asiento tapizado. - Вращающееся кресло, лаунж-кресло и скамейка с основанием в хромированной стали. Сиденье обитое.

### Struttura - Frame - Structure - Gestell - Estructura - Структура

#### S, T

Acciaio - Steel - Acier - Stahl - Acero - Сталь



Y  
Bianco - White



R  
Alluminio - Aluminium



C  
Cromo - Chrome

#### ATT, PA110, PA140

Acciaio - Steel - Acier - Stahl - Acero - Сталь



C  
Cromo - Chrome

#### PQ, SG

Acciaio - Steel - Acier - Stahl - Acero - Сталь



C  
Cromo - Chrome



K  
Satinato - Satin

### Scocca - Shell - Assise - Schale - Carcasa - Сидение И Спинка

Pelle - Leather - Peau - Leder - Piel - Натуральная кожа

Ecopelle - Ecoleather - Similicuir - Kunstleder - Ecopiel - Искусственная Кожа

Tessuto - Fabric - Tissu - Stoff - Tejido - Ткань

Vedi campionario per scegliere il colore - Check the swatches for colours - Voir l'échantillon pour choisir la couleur - Siehe Musterkarte um die Farbe zu wählen - Смотреть образцы для выбора цвета

### Dimensioni - Dimensions - Dimensions - Abmessung - Dimensiones - Размеры

#### Marsiglia S, T

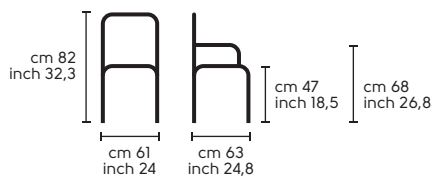

#### Marsiglia PQ

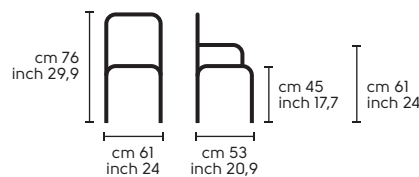

#### Marsiglia ATT

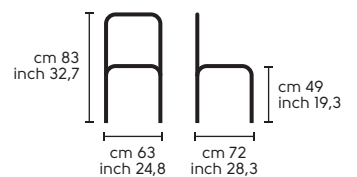

#### Marsiglia SG

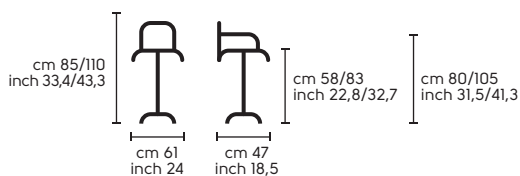

#### Marsiglia PA110

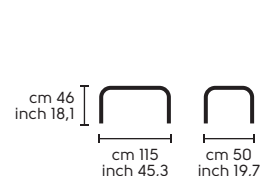

#### Marsiglia PA140

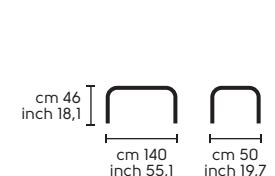

Design  
Midj R&D

# Island



.01

ISLAND S acciaio C, tessuto 63N,  
COMPOSIT 3 acciaio C, piano HPL LS5.

ISLAND S with steel frame C, fabric 63N,  
COMPOSIT 3 table with steel frame C, HPL top LS5.



S



TR



PT

#### Island

Poltrona fissa e girevole, con struttura in acciaio cromato o verniciato. Seduta imbottita. - Fix and swivel armchair with chromed or painted steel frame. Upholstered shell. - Fauteuil fixe et pivotante avec structure en acier chromé ou laqué. - Fest und drehbar Armstuhl mit verchromt oder lackiert Stahl

Struktur. Gepolsterte Schale. - Sillon fijo y giratorio con estructura en acero cromado o barnizado. Asiento tapizado. - Кресло фиксированное и вращающееся, с основанием в хромированной или крашенной стали. Сиденье обитое.

#### Struttura - Frame - Structure - Gestell - Estructura - Структура

S

Acciaio - Steel - Acier - Stahl - Acero - Сталь



**C**  
Cromo - Chrome

TR

Acciaio - Steel - Acier - Stahl - Acero - Сталь



**Y**  
Bianco - White



**R**  
Alluminio - Aluminium



**C**  
Cromo - Chrome

PT

Acciaio - Steel - Acier - Stahl - Acero - Сталь



**C**  
Cromo - Chrome



**K**  
Satinato - Satin

#### Scocca - Shell - Assise - Schale - Carcasa - Сидение И Спинка

Pelle - Leather - Peau - Leder - Piel - Натуральная кожа

Ecopelle - Ecoleather - Similicuir - Kunstleder - Ecopiel - Искусственная Кожа

Tessuto - Fabric - Tissu - Stoff - Tejido - Ткань

Vedi campionario per scegliere il colore - Check the swatches for colours - Voir l'échantillon pour choisir la couleur - Siehe Musterkarte um die Farbe zu wählen - Смотреть образцы для выбора цвета

#### Dimensioni - Dimensions - Dimensions - Abmessung - Dimensiones - Размеры

Island S

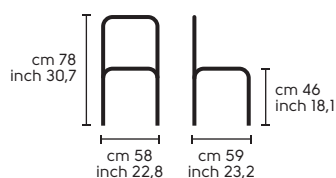

Island TR, PT

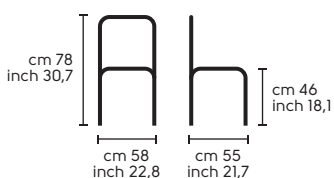

Design  
Walter Hösel  
Vivo







**.01**  
VIVO P acciaio C, ecopelle 7V1.  
VIVO P with steel frame C, ecoleather 7V1.

**.02**  
VIVO DPA acciaio C, cuoio U05.  
VIVO DPA with steel frame C, hide U05.





P



TA



DPB



DPA

**Vivo**  
Poltrona e dattilo con base a 5 razze con struttura in acciaio cromato. Seduta rivestita o imbottita. -  
Armchair and 5 ways swivel base with chrome steel frame. Hide or upholstered shell. - Fauteuil fixe et  
avec base à 5 rayons. Structure en acier chromé; assise en cuir ou revêtue. - Armstuhl und 5 Speiche

verchromt Stahl Gestell. Schale aus kernleder oder gepolsterte. - Sillon fijo e giratoria con base 5  
palos con estructura en acero cromado. Asiento en cuero o tapizado. - Кресло и офисный стул на  
основании крестовине-пятилучье, с основанием в хромированной стали. Сиденье обшито  
полутвердой кожей (cuoio) или обитое.

**Struttura - Frame - Structure - Gestell - Estructura -  
Структура**

Acciaio - Steel - Acier - Stahl - Acero - Сталь



**C**  
Cromo - Chrome

**Seduta e schienale - Seat and back - Assise et dossier -  
Sitz Und Lehne - Asiento y respaldo - сидение и спинка**

**P-CU, TA-CU, DPA-CU, DPB-CU**

Cuoio - Hide - Cuir - Kernleder - Cuero - Натуральная Кожа

Cuoio rigenerato - Rogenerated hide - Cuir régénéré -  
Rigeneriertes leder - Cuero regenerado - Регенерированная  
Кожа

Vedi campionario per scegliere il colore - Check the  
swatches for colours - Voir l'échantillon pour choisir la  
couleur - Siehe Musterkarte um die Farbe zu wählen -  
Смотреть образцы для выбора цвета

**Seduta e schienale - Seat and back - Assise et dossier -  
Sitz Und Lehne - Asiento y respaldo - сидение и спинка**

**P-TS, TA-TS, DPA-TS, DPB-TS**

Pelle - Leather - Peau - Leder - Piel - Натуральная кожа

Ecopelle - Ecoleather - Similicuir - Kunstleder - Ecopiel -  
Искусственная Кожа

Tessuto - Fabric - Tissu - Stoff - Tejido - Ткань

Vedi campionario per scegliere il colore - Check the  
swatches for colours - Voir l'échantillon pour choisir la  
couleur - Siehe Musterkarte um die Farbe zu wählen -  
Смотреть образцы для выбора цвета

**Dimensioni - Dimensions - Dimensions - Abmessung - Dimensiones - Размеры**

**Vivo P-CU, P-TS**

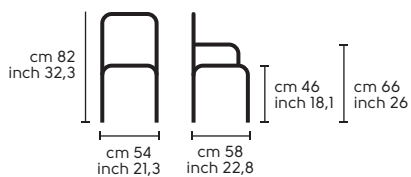

**Vivo TA-CU, TA-TS**

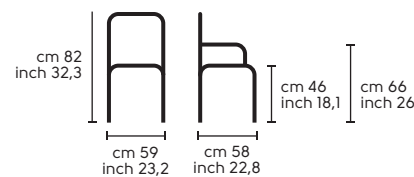

**Vivo DPA-CU, DPA-TS**

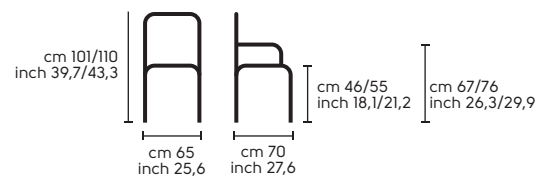

**Vivo DPB-CU, DPB-TS**

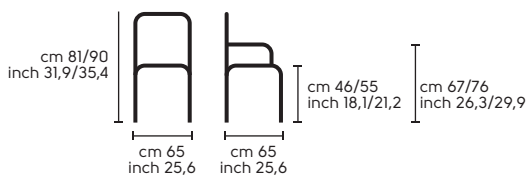

Design  
Midj R&D  
H5







**.01.03**

H5 LR acciaio C, ecopelle 722,  
ARMANDO 290x100 tavolo fisso, acciaio Y.  
H5 LR with steel frame C, ecoleather 722,  
ARMANDO 290x100 fix table with steel frame Y.

**.02**

H5 DPL acciaio C, ecopelle 722.frame Y.  
H5 DPL with steel frame C, ecoleather 722.



.04  
H5 DP-LR acciaio C, ecopelle 726.  
H5 DP-LR with steel frame C, ecoleather 726.





LR



S



XL



DP-L

**H5**  
Poltrona e dattilo con base a 5 razze con struttura in acciaio cromato. Seduta rivestita o imbottita. -  
Armchair and 5 ways swivel base with chrome steel frame. Upholstered shell. - Fauteuil fixe et avec base  
à 5 rayons. Structure en acier chromé. Assise revêtue. - Armstuhl und 5 Speiche verchromt Stahl Gestell.

Gepolsterte Schale. - Sillon fijo e giratoria con base 5 palos con estructura en acero cromado.  
Asiento tapizado. - Кресло и офисный стул на основании крестовине-пятилучье, с основанием в  
хромированной стали. Сиденье обитое.

**Struttura - Frame - Structure - Gestell - Estructura - Структура**

Acciaio - Steel - Acier - Stahl - Acero - Сталь



**C**  
Cromo - Chrome

**Seduta e schienale - Seat and back - Assise et dossier - Sitz Und Lehne - Asiento y respaldo - сидение и спинка**

**S, DP-S**

Cuoio - Hide - Cuir - Kernleder - Cuero - Натуральная Кожа

Cuoio rigenerato - Rogenerated hide - Cuir régénéré -  
Rigeneriertes leder - Cuero regenerado - Регенерированная  
Кожа

**L, L-R, XL, DP-L, DP-LR**

Pelle - Leather - Peau - Leder - Piel - Натуральная кожа

Ecopelle - Ecoleather - Similicuir - Kunstleder - Escopiel -  
Искусственная Кожа

Tessuto - Fabric - Tissu - Stoff - Tejido - Ткань

Vedi campionario per scegliere il colore - Check the  
swatches for colours - Voir l'échantillon pour choisir la  
couleur - Siehe Musterkarte um die Farbe zu wählen -  
Смотреть образцы для выбора цвета

**Seduta e schienale - Seat and back - Assise et dossier - Sitz Und Lehne - Asiento y respaldo - сидение и спинка**

**MO**

Elastico - Elastic - élastique - elastic - elástico - резинка

Vedi campionario per scegliere il colore - Check the  
swatches for colours - Voir l'échantillon pour choisir la  
couleur - Siehe Musterkarte um die Farbe zu wählen -  
Смотреть образцы для выбора цвета

**Dimensioni - Dimensions - Dimensions - Abmessung - Dimensiones - Размеры**

**H5 S**

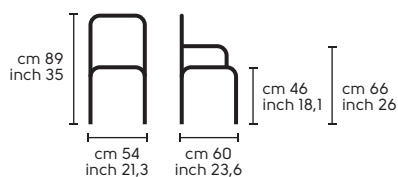

**H5 L, LR, XL**

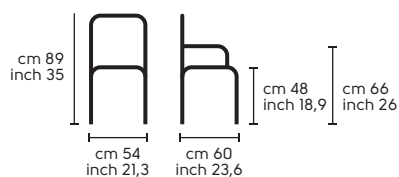

**H5 DP-S, DP-L, DP-LR**

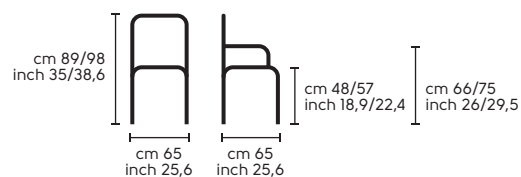

Design  
Midj R&D

# Istar





.01

ISTAR acciaio C, ecopelle 722.

ISTAR with steel frame C, ecoleather 722.



DB



DPB



DA



DPA

**Istar**

Sedia con struttura in acciaio cromato. Scocca imbottita. - Chair with chrome steel structure. Upholstered shell. - Chaise avec structure en acier chromé. Assise revêtue. - Stuhl mit verchromt

Struktur. Gepolsterte Schale. - Silla con estructura en acero cromado. Carcasa tapizada. - Стул с основанием в хромированной или крашенной стали. Каркас обитый.

**Struttura - Frame - Structure - Gestell - Estructura - Структура**

Acciaio - Steel - Acier - Stahl - Acero - Сталь



**C**  
Cromo - Chrome

**Scocca - Shell - Assise - Schale - Carcasa - Сидение И Спинка**

Pelle - Leather - Peau - Leder - Piel - Натуральная кожа

Ecopelle - Ecoleather - Similicuir - Kunstleder - Escopiel - Искусственная Кожа

Tessuto - Fabric - Tissu - Stoff - Tejido - Ткань

Vedi campionario per scegliere il colore - Check the swatches for colours - Voir l'échantillon pour choisir la couleur - Siehe Musterkarte um die Farbe zu wählen - Смотреть образцы для выбора цвета

**Dimensioni - Dimensions - Dimensions - Abmessung - Dimensiones - Размеры**

**Istar DA, DP-A**

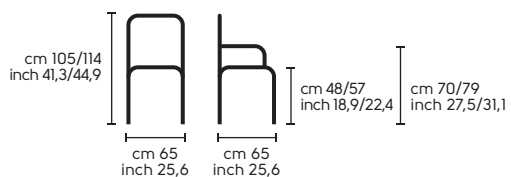

**Istar DB, DP-B**

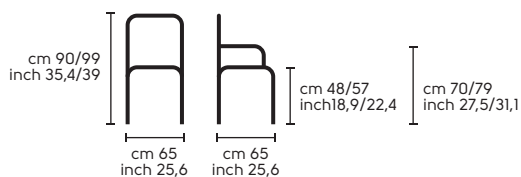

Design  
Studio Balutto associati  
Bongo



.01

BONGO MT acciaio C, ecopelle 733, metacrilato H30.

BONGO MT with steel frame C, ecoleather 733, methacrylate H30.



#### Bongo

Sgabello girevole e regolabile in altezza con struttura in acciaio cromato. Sedile rivestito, schienale rivestito, precomposto, metacrilato o imbottito. - Swivel and high-adjustable stool with chrome steel frame. Upholstered seat, back in hide, multi-laminar wood, methacrylate or upholstered. - Tabouret pivotante et réglable en hauteur avec structure en acier chromé. Assise revêtue, dossier en cuir, précomposé, méthacrylate ou revêtu. - Drehbar und verstellbar Hocker mit verchromt Stahl Struktur. Gepolsterte Sitz, Lehne aus Kernleder, Laminat Holz, Metachrylate oder gepolsterte. -

Taburete giratorio y regulable en altura con estructura en acero cromado. Asiento tapizado, respaldo en cuero, precompuesto madera, metacrilato o tapizado. - Барный стул вращающийся и регулирующийся по высоте, с основанием в хромированной стали. Сиденье обшито, спинка обшита твердой кожей (cuero), выполнена в шпоне, метакрилате или обитая.

#### Struttura - Frame - Structure - Gestell - Estructura - Структура

Acciaio - Steel - Acier - Stahl - Acero - Сталь



**C**  
Cromo - Chrome

#### Seduta - Seat - Assise - Sitz - Asiento - сидение

Pelle - Leather - Peau - Leder - Piel - Натуральная кожа

Ecopelle - Ecoleather - Similicuir - Kunstleder - Ecopiel - Искусственная Кожа

Tessuto - Fabric - Tissu - Stoff - Tejido - Ткань

Vedi campionario per scegliere il colore - Check the swatches for colours - Voir l'échantillon pour choisir la couleur - Siehe Musterkarte um die Farbe zu wählen - Смотреть образцы для выбора цвета

#### Schienale - Back - Dossier - Lehne - Respaldo - Назад

#### MT

metacrilato trasparente - methacrylate transparent - méthacrylate transparent - metacrilato transparente - метакрилата прозрачный

#### LG

Legni - Wood - Bois - Holz - Madera - Дерево



**L26**  
Rovere moro - Dark Oak

#### TS

Pelle - Leather - Peau - Leder - Piel - Натуральная кожа

Ecopelle - Ecoleather - Similicuir - Kunstleder - Ecopiel - Искусственная Кожа

Tessuto - Fabric - Tissu - Stoff - Tejido - Ткань

#### CU

Cuoio - Hide - Cuir - Kernleder - Cuero - Натуральная Кожа

Cuoio rigenerato - Rigenenerated hide - Cuir régénéré - Rigeniertes leder - Cuero regenerado - Регенерированная Кожа

Vedi campionario per scegliere il colore - Check the swatches for colours - Voir l'échantillon pour choisir la couleur - Siehe Musterkarte um die Farbe zu wählen - Смотреть образцы для выбора цвета

#### Dimensioni - Dimensions - Dimensions - Abmessung - Dimensiones - Размеры

#### Bongo

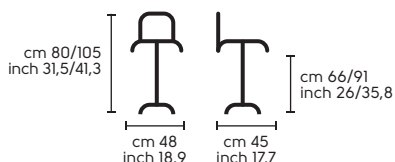

Design  
Paolo Vernier

# John



**.01 .02**

JOHN acciaio C, cuoio U01.

JOHN with steel frame C, hide U01.

**John**

Sgabello girevole e regolabile in altezza con struttura in acciaio cromato. Seduta rivestita. - Swivel and high-adjustable stool with chrome steel frame. Hide seat. - Tabouret pivotante et ajustable en hauteur avec structure en acier chromé. Assise revêtue - Drehbar und verstellbar Hocker mit verchromt Stahl

Struktur. Kernleder Sitz. - Taburete giratorio y regulable en altura con estructura en acero cromado. Asiento en cuero. - Барный стул вращающийся и регулирующий по высоте, с основанием в хромированной стали. Сиденье обшито полутвердой кожей (cuoio).

**Struttura - Frame - Structure - Gestell - Estructura - Структура**

Acciaio - Steel - Acier - Stahl - Acero - Сталь

**C**  
Cromo - Chrome**Scocca - Shell - Assise - Schale - Carcasa - Сидение И Спинка**

Cuoio - Hide - Cuir - Kernleder - Cuero - Naturalная Кожа

Cuoio rigenerato - Rogenerated hide - Cuir régénéré - Rigeniertes leder - Cuero regenerado - Регенерированная Кожа

Vedi campionario per scegliere il colore - Check the swatches for colours - Voir l'échantillon pour choisir la couleur - Siehe Musterkarte um die Farbe zu wählen - Смотреть образцы для выбора цвета

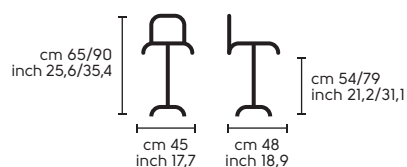
**Dimensioni - Dimensions - Dimensions - Abmessung - Dimensiones - Размеры****John**

Design  
Paolo Vernier  
Mark



**.01**  
 MARK H65 acciaio C, pelle VII.  
 MARK H65 with steel frame C, leather VII.



SG



H65, H75

**Mark**

Sgabello fisso, girevole e regolabile in altezza con struttura in acciaio cromato. Seduta imbottita o rivestita. - Fix and swivel and high-adjustable stool with chrome steel frame. Upholstered seat. - Tabouret pivotante et réglable en hauteur avec structure en acier chromé. Assise revêtue. - Fest, drehbar und verstellbar Hocker mit verchromt Stahl Struktur. Gepolsterte Sitz. -

Taburete fijo, giratorio y regulable en altura con estructura en acero cromado. Asiento tapizado. - Барный стул фиксированный, вращающийся или регулирующий по высоте с основанием в хромированной стали. Сиденье обитое.

**Struttura - Frame - Structure - Gestell - Estructura - Структура**

**H65-CU, H75-CU, H65-TS, H75-TS**

Acciaio - Steel - Acier - Stahl - Acero - Сталь



**C**  
Cromo - Chrome

**SG-CU, SG-TS**

Acciaio - Steel - Acier - Stahl - Acero - Сталь



**C**  
Cromo - Chrome



**K**  
Satinato-Satin

**Scocca - Shell - Assise - Schale - Carcasa - Сидение И Спинка**

**H65-CU, H75-CU, SG-CU**

Cuoio - Hide - Cuir - Kernleder - Cuero - Натуральная Кожа

Cuoio rigenerato - Rogenerated hide - Cuir régénéré - Rigeneriertes leder - Cuero regenerado - Регенерированная Кожа

**H65-TS, H75-TS, SG-TS**

Pelle - Leather - Peau - Leder - Piel - Натуральная кожа

Ecopelle - Ecoleather - Similicuir - Kunstleder - Escopiel - Искусственная Кожа

Tessuto - Fabric - Tissu - Stoff - Tejido - Ткань

Vedi campionario per scegliere il colore - Check the swatches for colours - Voir l'échantillon pour choisir la couleur - Siehe Musterkarte um die Farbe zu wählen - Смотреть образцы для выбора цвета

**Dimensioni - Dimensions - Dimensions - Abmessung - Dimensiones - Размеры**

**Mark H65-CU, H65-TS**

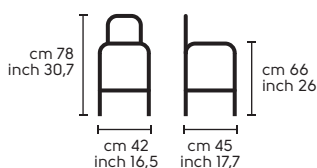

**Mark H75-CU, H75-TS**

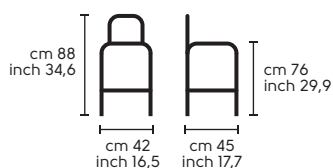

**Mark SG-CU, SG-TS**

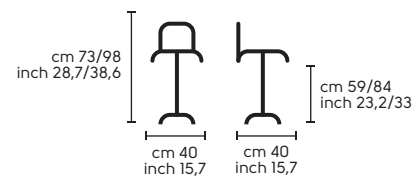

Design  
Rudy Vernier

# Kayak





.01

KAYAK acciaio C,  
precomposto L40.

KAYAK with steel frame C,  
veneer L40.



**Kayak**  
Sgabello con struttura in acciaio cromato. Seduta in impiallacciato. - Stool with chrome steel frame.  
Veneered seat. - Tabouret avec structure en acier chromé. Assise en laqué. - Hocker mit verchromt Stahl  
Gestell. Sitz aus Holz furniert. - Taburete con estructura en acero cromado. Asiento en contrachapado.  
Барный стул с основанием в хромированной стали. Сиденье в шпоне.

**Struttura - Frame - Structure - Gestell - Estructura - Структура**

Acciaio - Steel - Acier - Stahl - Acero - Сталь

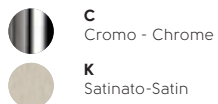

**Scocca - Shell - Assise - Schale - Carcasa - Сидение И Спинка**

Legni - Wood - Bois - Holz - Madera - Дерево



**Dimensioni - Dimensions - Dimensions - Abmessung - Dimensiones - Размеры**

**Kayak**

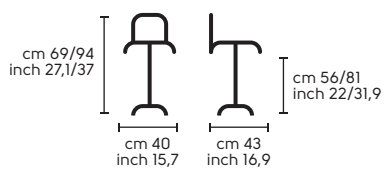

Design  
Mauro Fadel  
ZOW



.01

ZOW acciaio C, cuoio U42.

ZOW with steel frame C, hide U42.

**Zow**

Sgabello girevole e regolabile in altezza con struttura in acciaio cromato. Seduta rivestita. - Swivel and high-adjustable stool with chrome steel frame. Hide seat. - Tabouret pivotante et ajustable en hauteur avec structure en acier chromé. Assise revêtue. - Drehbar und verstellbar Hocker mit verchromt Stahl

Struktur. Kernleder Sitz. - Taburete giratorio y regulable en altura con estructura en acero cromado. Asiento en cuero. - Барный стул фиксированный, вращающийся и регулирующий по высоте с основанием в хромированной стали. Сиденье обшито полутвердой кожей (сuoio).

**Struttura - Frame - Structure - Gestell - Estructura - Структура**

Acciaio - Steel - Acier - Stahl - Acero - Сталь



**C**  
Cromo - Chrome

**Scocca - Shell - Assise - Schale - Carcasa - Сидение И Спинка**

Cuoio - Hide - Cuir - Kernleder - Cuero - Натуральная Кожа

Vedi campionario per scegliere il colore - Check the swatches for colours - Voir l'échantillon pour choisir la couleur - Siehe Musterkarte um die Farbe zu wählen - Смотреть образцы для выбора цвета

**Dimensioni - Dimensions - Abmessung - Dimensiones - Размеры**

**Zow**

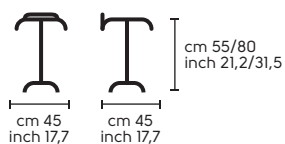

Design  
Cappellini & Licheri

# Happy Kreeek



.01

HAPPY KREEK acciaio C, ecopelle 722 e 730.

HAPPY KREEK with steel frame C,  
ecoleather 722 and 730.



#### Happy Kreek

Sgabello girevole e regolabile in altezza con struttura in acciaio cromato. Sedile e schienale imbottito.  
- Swivel and high-adjustable stool with chrome steel frame. Upholstered seat. - Tabouret pivotante et réglable en hauteur avec structure en acier chromé. Assise revêtue. - Drehbar und verstellbar Hocker

mit verchromt Stahl Struktur. Gepolsterte Sitz. - Taburete giratorio y regulable en altura con estructura en acero cromado. Asiento y respaldo tapizado. - Барный стул фиксированный, вращающийся или регулирующий по высоте с основанием в хромированной стали. Сиденье и спинка обитые.

#### Struttura - Frame - Structure - Gestell - Estructura - Структура

Acciaio - Steel - Acier - Stahl - Acero - Сталь



**C**  
Cromo - Chrome



**K**  
Satinato-Satin

#### Seduta e schienale - Seat and back - Assise et dossier - Sitz Und Lehne - Asiento y respaldo - сидение и спинка

Pelle - Leather - Peau - Leder - Piel - Натуральная кожа

Ecopelle - Ecoleather - Similicuir - Kunstleder - Escopiel - Искусственная Кожа

Tessuto - Fabric - Tissu - Stoff - Tejido - Ткань

Vedi campionario per scegliere il colore - Check the swatches for colours - Voir l'échantillon pour choisir la couleur - Siehe Musterkarte um die Farbe zu wählen - Смотреть образцы для выбора цвета

#### Dimensioni - Dimensions - Dimensions - Abmessung - Dimensiones - Размеры

##### Happy Kreek

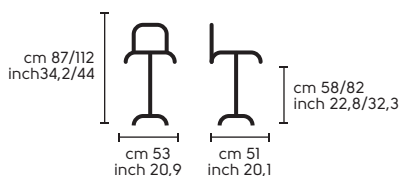

Design  
Franca Violin  
Afra





**.01**  
 AFRA P acciaio Z, tessuto "pied de poule".  
 AFRA P with steel frame Z, "pied de poule" fabric.

**Afra**  
 Poltrona, attesa e divano in acciaio cromato o nichel nero. Seduta imbottita. - Armchair lounge chair and sofa with chrome steel or black nickel frame. Upholstered seat. - Fauteuil, accueil et canapé avec structure en acier chromé ou nickel noir. Assise revêtue. - Armstuhl, lounge Stuhl und Sofa mit Stahl

oder Schwarz nickel Struktur. Gepolsterte Sitz. - Sillon, espera o sofa en acero cromado o niquel negro. Asiento tapizado - Кресло, лаунж-кресло и диван с основанием в хромированной стали или черном никеле. Сиденье обитое.

**Struttura - Frame - Structure - Gestell - Estructura - Структура**

Acciaio - Steel - Acier - Stahl - Acero - Сталь



**C**  
 Cromo - Chrome



**Z**  
 Nichel nero - Black nickel

**Scocca - Shell - Assise - Schale - Carcasa - Сидение И Спинка**

Ecopelle - Ecoleather - Similicuir - Kunstleder - Escopiel - Искусственная Кожа

Tessuto - Fabric - Tissu - Stoff - Tejido - Ткань

Vedi campionario per scegliere il colore - Check the swatches for colours - Voir l'échantillon pour choisir la couleur - Siehe Musterkarte um die Farbe zu wählen - Смотреть образцы для выбора цвета

**Dimensioni - Dimensions - Dimensions - Abmessung - Dimensiones - Размеры**

**Afra P**

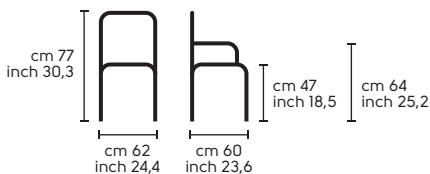

**Afra ATT**

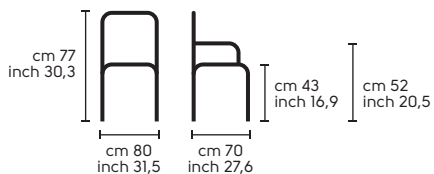

**Afra DIV**

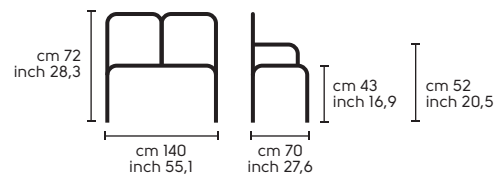

Design  
Mauro Fadel

# Billy





.01

BILLY 1 acciaio C, ecopelle 736,  
WALTER coffee table acciaio Y, piano inox satinato.

BILLY 1 with steel frame C, ecoleather 736,  
WALTER coffee table with steel frame Y, satin  
stainless top.



0



1



2



3



3-HPL

#### Billy 0-TS, 1-TS, 2-RS, 3-TS

Poltrona e divanetto con struttura in acciaio cromato. Seduta imbottita. - Armchair and sofa with chrome steel frame. Upholstered shell. - Fauteuil et canapé avec structure en acier chromé. Assise revêtue. - Armstuhl und Sofa mit verchromt Stahl Struktur. Gepolsterte Schale. - Sillon y sofa con estructura en acero cromado: Asiento tapizado. - Кресло и небольшой диван с основанием в хромированной стали. Сиденье обито.

#### Billy 3-HPL

Coffee table con struttura acciaio cromato. Piano in HPL. - Coffee table with chrome. Hpl top. - Table basse avec structure en acier chromé. Plateau en HPL. - Couchtisch mit verchromt Stahl Struktur. Platte aus Hpl. - Mesa café con estructura en acero cromado o barnizado. Sobre en HPL. - Кофейный столик с основанием в хромированной стали. Столешница в HPL.

#### Struttura - Frame - Structure - Gestell - Estructura - Структура

Acciaio - Steel - Acier - Stahl - Acero - Сталь



C  
Cromo - Chrome

#### Seduta e schienale - Seat and back - Assise et dossier - Sitz Und Lehne - Asiento y respaldo - сидение и спинка

#### 0-TS, 1-TS, 2-TS, 3-TS

Pelle - Leather - Peau - Leder - Piel - Натуральная кожа

Ecopelle - Ecoleather - Similicuir - Kunstleder - Ecopiel - Искусственная Кожа

Tessuto - Fabric - Tissue - Stoff - Tejido - Ткань

#### 3-HPL

HPL

Vedi campionario per scegliere il colore - Check the swatches for colours - Voir l'échantillon pour choisir la couleur - Siehe Musterkarte um die Farbe zu wählen - Смотреть образцы для выбора цвета

#### Dimensioni - Dimensions - Dimensions - Abmessung - Dimensiones - Размеры

##### Billy 0-TS

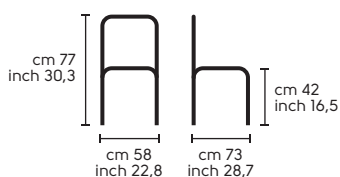

##### Billy 1-TS

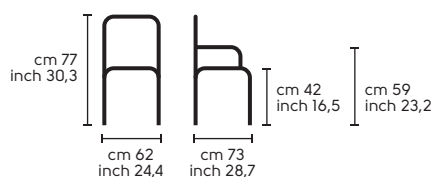

##### Billy 2-TS

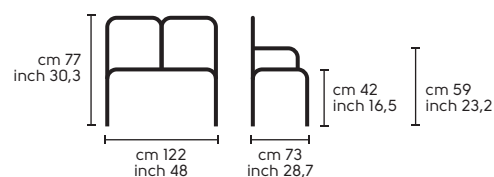

##### Billy 3-TS

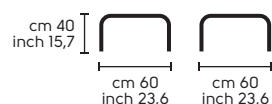

##### Billy 3HPL

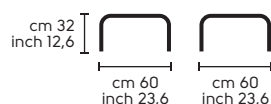

Design  
Franca Violin  
Kasha





**.01**  
 KASHA poltrona struttura rivestita tessuto cliente.  
 KASHA armchair with steel frame client fabric upholstered

**Kasha**  
 Poltrona con struttura rivestita in cuoio o imbottita. Seduta imbottita. - Armchair with steel frame fully upholstered. Upholstered seat. - Fauteuil avec structure en cuir ou revêtu. Assise revêtue. - Armstuhl mit Stahl Struktur vollig gepolsterte. - Sillon con estructura revestida en cuero o tapizada. Asiento

tapizado. - Кресло с основанием обшитым полутвердой кожей (сuoio) или обитым. Сиденье обитое.

**Struttura - Frame - Structure - Gestell - Estructura - Структура**

**CU**  
 Cuoio - Hide - Cuir - Kernleder - Cuero - Натуральная Кожа

**TS**  
 Pelle - Leather - Peau - Leder - Piel - Натуральная кожа  
 Ecopelle - Ecoleather - Similicuir - Kunstleder - Ecopiel - Искусственная Кожа  
 Tessuto - Fabric - Tissu - Stoff - Tejido - Ткань

Vedi campionario per scegliere il colore - Check the swatches for colours - Voir l'échantillon pour choisir la couleur - Siehe Musterkarte um die Farbe zu wählen - Смотреть образцы для выбора цвета

**Seduta e schienale - Seat and back - Assise et dossier - Sitz Und Lehne - Asiento y respaldo - сидение и спинка**

Ecopelle - Ecoleather - Similicuir - Kunstleder - Ecopiel - Искусственная Кожа

Tessuto - Fabric - Tissu - Stoff - Tejido - Ткань

Vedi campionario per scegliere il colore - Check the swatches for colours - Voir l'échantillon pour choisir la couleur - Siehe Musterkarte um die Farbe zu wählen - Смотреть образцы для выбора цвета

**Dimensioni - Dimensions - Abmessung - Dimensiones - Размеры**

**Kasha**

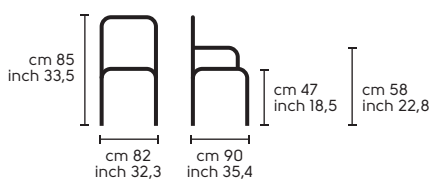

Design  
Mauro Fadel

# Relax



.01

RELAX CU chaise longue acciaio C,  
rigenerato di cuoio Z05.

RELAX CU chaise longue with steel frame C,  
rigenerated hide Z05.

.02

RELAX TS chaise longue acciaio C, tessuto 633.

RELAX TS chaise longue with steel frame C,  
fabric 633.

.02



**Relax**

Chaise longue con struttura in acciaio cromato. Seduta rivestita o imbottita. - Chaise longue with chrome steel structure. Hide or upholstered shell. - Chaise longue avec structure en acier chromé. Assise revêtre. - Chaise Longue mit verchromt Stahl Struktur. Kernleder oder

gepolsterte Schale. - Chaise longue con estructura en acero cromado. Asiento en cuero o tapizada. - Шезлонг с основанием в хромированной стали. Сиденье обшито полутвердой кожей (cuoio) или обитое.

**Struttura - Frame - Structure - Gestell - Estructura - Структура**

Acciaio - Steel - Acier - Stahl - Acero - Сталь



**C**  
Cromo - Chrome

**Scocca - Shell - Assise - Schale - Carcasa - Сидение И Спинка**

**CU**

Cuoio - Hide - Cuir - Kernleder - Cuero - Натуральная Кожа

Cuoio rigenerato - Rigenerated hide - Cuir régénéré - Rigeneriertes leder - Cuero regenerado - Регенерированная Кожа

Pelle fiore - Top-grain leather - Plein fleur - Leder fiore Flor de piel - Натуральная Кожа fiore

**TS**

Pelle - Leather - Peau - Leder - Piel - Натуральная кожа

Ecopelle - Ecoleather - Similicuir - Kunstleder - Escopiel - Искусственная Кожа

Tessuto - Fabric - Tissu - Stoff - Tejido - Ткань

Vedi campionario per scegliere il colore - Check the swatches for colours - Voir l'échantillon pour choisir la couleur - Siehe Musterkarte um die Farbe zu wählen - Смотреть образцы для выбора цвета

**Dimensioni - Dimensions - Dimensions - Abmessung - Dimensiones - Размеры**

**Relax**



Design  
Renato Bbrunetta

# T.T. Relax

.01



.01

T.T. RELAX chaise longue acciaio C,  
ecopelle 722.

T.T. RELAX chaise longue with steel  
frame C, ecoleather 722.



**T.T. Relax**

Chaise longue con struttura in acciaio cromato. Seduta imbottita. - Chaise longue with chrome steel structure. Upholstered shell. - Chaise longue avec structure en acier chromé. Assise revêtue. - Chaise Longue mit verchromt Stahl Struktur. Gepolsterte Schale. -

Chaise longue con estructura en acero cromado. Asiento tapizada. - Шезлонг с основанием в хромированной стали. Сиденье обшито полутвердой кожей (cuoio) или обитое.

**Struttura - Frame - Structure - Gestell - Estructura - Структура**

Acciaio - Steel - Acier - Stahl - Acero - Сталь



**C**  
Cromo - Chrome

**Scocca - Shell - Assise - Schale - Carcasa - Сидение И Спинка**

Pelle - Leather - Peau - Leder - Piel - Натуральная кожа

Ecopelle - Ecoleather - Similicuir - Kunstleder - Ecopiel - Искусственная Кожа

Tessuto - Fabric - Tissu - Stoff - Tejido - Ткань

Vedi campionario per scegliere il colore - Check the swatches for colours - Voir l'échantillon pour choisir la couleur - Siehe Musterkarte um die Farbe zu wählen - Смотреть образцы для выбора цвета

**Dimensioni - Dimensions - Dimensionen - Abmessung - Dimensiones - Размеры**

**Relax**

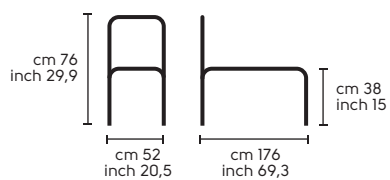

Design  
Area 44

# Mask





**.01**  
 MASK acciaio C, ecopelle 722.  
 MASK with steel frame C,  
 ecoleather 722.



**Mask**

Sedia da attesa con struttura in acciaio cromato o verniciato. Seduta imbottita. - Lounge chair with chrome or painted steel frame. Upholstered shell. - Accueil avec structure en acier chromé ou laqué. Assise revêtue. - Chaise Longue mit verchromt Stahl Struktur. Gepolsterte Schale. - Silla de espera

con estructura en acero cromado o barnizado. Asiento tapizado. - Лаунж-стул с основанием в хромированной или крашенной стали. Сиденье обитое.

**Struttura - Frame - Structure - Gestell - Estructura - Структура**

Acciaio - Steel - Acier - Stahl - Acero - Сталь



**Y**  
 Bianco - White



**C**  
 Cromo - Chrome

**Scocca - Shell - Assise - Schale - Carcasa - Сидение И Спинка**

Pelle - Leather - Peau - Leder - Piel - Натуральная кожа

Ecopelle - Ecoleather - Similicuir - Kunstleder - Ecopiel - Искусственная Кожа

Tessuto - Fabric - Tissu - Stoff - Tejido - Ткань

Vedi campionario per scegliere il colore - Check the swatches for colours - Voir l'échantillon pour choisir la couleur - Siehe Musterkarte um die Farbe zu wählen - Смотреть образцы для выбора цвета

**Dimensioni - Dimensions - Dimensions - Abmessung - Dimensiones - Размеры**

**Mask**

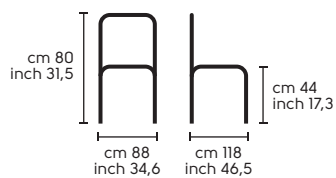





Design  
Studio Balutto Associati

# Armando











**.01**  
ARMANDO 290x100 acciaio D.  
ARMANDO 290x100 with steel  
frame D.

**.02**  
ARMANDO 160x90 tavolo fisso acciaio Y,  
LIÙ D e LIÙ DP acciaio C, ecopelle 722.  
ARMANDO 160x90 tavolo fisso acciaio Y,  
LIÙ D e LIÙ DP with steel frame C,  
ecoleather 722.

**.03**  
ARMANDO 80x80 tavolo fisso acciaio D.  
NENÈ polipropilene P04.  
ARMANDO 80x80 fix tablewith steel frame D.  
NENÈ polypropylene P04.





#### Armando fisso

Tavolo fisso con struttura e piano in acciaio. - Table with metal frame and top. - Table avec structure et plateau en acier. - Tisch mit Gestell und aus Stahl. - Mesa con estructura y sobre en acero. - Стол нераскладной с каркасом и столешницей из стали

#### Struttura - Frame - Structure - Gestell - Estructura - Структура

Acciaio - Steel - Acier - Stahl - Acero - Сталь

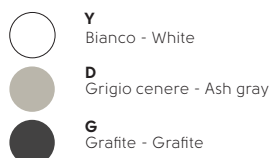

#### Piano - Top - Plateau - Platte - Sobre - Столешница

Acciaio - Steel - Acier - Stahl - Acero - Сталь

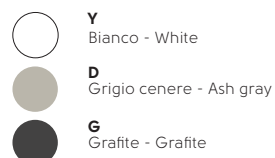

#### Dimensioni - Dimensions - Dimensions - Abmessung - Dimensiones - Размеры

##### Armando 80x80

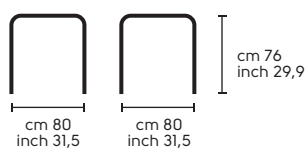

##### Armando 90x90

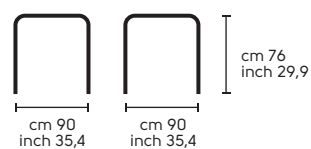

##### Armando 160x90

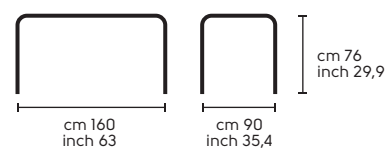

##### Armando 200x100

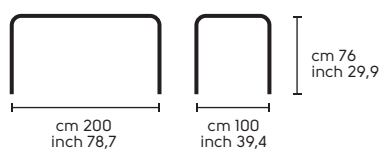

##### Armando 290x100

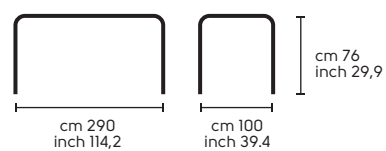

Design  
Paolo Vernier

# Toronto









.02



.03

**.01**

TORONTO 300x106 tavolo fissato legno L26, piano legno L26.  
TORONTO 300x106 wooden fixed table L26, wooden top L26.

**.02 .03**

TORONTO 200x100 tavolo fissato acciaio Y, piano vetro V30.  
TORONTO 200x100 fixed table with steel frame Y, glass top V30.

**.04**

TORONTO 200x100 tavolo fissato legno L40, piano vetro V30.  
TORONTO 200x100 wooden fixed table L40, glass top V30.



**Toronto fisso LG**

Tavolo fisso con gambe in: cristallo, acciaio o legno. Piano impiallacciato.  
 A richiesta kit passacavo. - Table with glass, metal or wooden legs. Wooden top. Cable kit on request.  
 - Table avec structure en verre, acier ou bois. Plateau en bois. Kit de passe-fil sur demande. - Tisch mit Gestell aus Glas, Stahl oder Holz. Platte aus Holz. kable Kit auf Anfrage. - Mesa con estructura en verre, acero o madera. Sobre en madera. Kit de cables a solicitud. - Стол нераскладной с ножками из: стекла, стали или дерева. Столешница из шпона. По запросу - набор для кабельного ввода.

**Struttura - Frame - Structure - Gestell - Estructura - Структура**

Cristallo - Glass - Verre - Glas - Verre - Стекло

**V30**  
Trasparente - Transparent

Acciaio - Steel - Acier - Stahl - Acero - Сталь

**Y**  
Bianco - White

**K**  
Satinato - Satin

Legni - Wood - Bois - Holz - Madera - Дерево

**L26**  
Rovere moro - Dark Oak

**L40**  
Rovere naturale - Natural Oak

**Piano - Top - Plateau - Platte - Sobre - Столешница**

Impiallacciato - Veneered wood - Bois plaqué - Holz furniert - Madera contra-Chapada - Шпон

\* **L26**  
Rovere moro - Dark Oak

\* Disponibile solo per versione 200x100 e 300x106 - Available only 200x100 and 300x106

**Toronto fisso VT**

Tavolo fisso con gambe in: cristallo, acciaio o legno. Piano in cristallo - Fix table with legs: crystal, steel or wood. Glass top - Table fixe avec pieds en: cristal, acier ou bois. Plateau cristal. - Tisch, nicht ausziehbar, mit Glass-, Stahl- oder Holzfüßen. Glasplatte. - Mesa fija con patas: cristal, acero o madera. Sobre de cristal. - Стол нераскладной с ножками из: стекла, стали или дерева. Столешница из стекла.

**Struttura - Frame - Structure - Gestell - Estructura - Структура**

Cristallo - Glass - Verre - Glas - Verre - Стекло

**V30**  
Trasparente - Transparent

Acciaio - Steel - Acier - Stahl - Acero - Сталь

**Y**  
Bianco - White

**K**  
Satinato - Satin

Legni - Wood - Bois - Holz - Madera - Дерево

**L26**  
Rovere moro - Dark Oak

**L40**  
Rovere naturale - Natural Oak

**Piano - Top - Plateau - Platte - Sobre - Столешница**

Cristallo - Glass - Verre - Glas - Verre - Стекло

\*\* **V30**  
Trasparente - Transparent

\*\* Disponibile solo per versione 160x100 e 200x100 - Available only 160x100 and 200x100

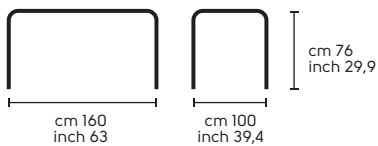
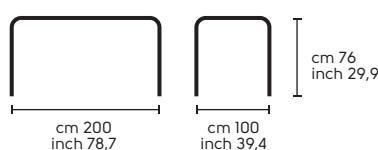
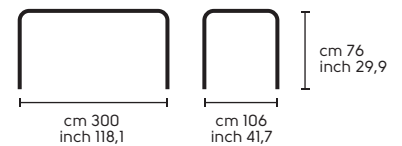
**Dimensioni - Dimensions - Dimensions - Abmessung - Dimensiones - Размеры****Toronto 160x100****Toronto 200x100****Toronto 300x106**

Design  
Cappellini & Licheri

# Portofino











**.01**  
 PORTOFINO 200x106 tavolo fisso  
 acciaio C, piano legno LH1,  
 PORTOFINO sedia acciaio C,  
 pelle F34.  
 PORTOFINO 200x106 fix table with  
 steel frame C, wooden top LH1,  
 PORTOFINO chair with steel frame  
 C, leather F34.

**.02**  
 PORTOFINO 200x106 tavolo fisso  
 acciaio C, piano vetro V3E,  
 PORTOFINO sedia acciaio C,  
 ecopelle 722.  
 PORTOFINO 200x106 fix table  
 with steel frame C, glass top V3E,  
 PORTOFINO chair with steel frame  
 C, ecoleather 722.

**Portofino**

Tavolo fisso con struttura in acciaio. Piani in: cristallo, massello o impiallacciato. - Fix table with metal frame. Top in glass, solid walnut bak or veneered wood. - Table avec structure en acier. Plateau en verre, massif ou bois. - Tisch mit Stahlgestell. Platte aus Glas oder kratzfestig Glas, Holz. -

Mesa con estructura en acero. Sobre en cristal, cristal antirayaduras, madera. - Стол нераскладной со стальным каркасом и столешницей из: стекла, устойчивого к царапинам стекла или шпона

**Struttura - Frame - Structure - Gestell - Estructura - Структура**

Acciaio - Steel - Acier - Stahl - Acero - Сталь

- Y**  
Bianco - White
- S**  
Corda - Corda
- G**  
Grafite - Grafite
- C**  
Cromo - Chrome
- Z**  
Nichel nero - Black nickel

**Piano - Top - Plateau - Platte - Sobre - Столешница**

Legno - Wood - Bois - Holz - Madera - Дерево

- LM1**  
Massello di noce corteccia - Solid walnut bark
- Impiallacciato - Veneered wood - Bois plaqué - Holz furniert - Madera contra-Chapada - Шпон
- \* **L14**  
Noce - Walnut
- \* **L26**  
Rovere moro - Dark Oak
- Cristallo - Glass - Verre - Glas - Verre - Стекло
- \*\* **V30**  
Trasparente - Transparent

\* Disponibile solo per versione 190x106 e 250x106 - Available only 190x106 and 250x106

\*\* Disponibile solo per versione 200x106 e 250x106 - Available only 200x106 and 250x106

**Dimensioni - Dimensions - Dimensions - Abmessung - Dimensiones - Размеры**

**Portofino 190x106**

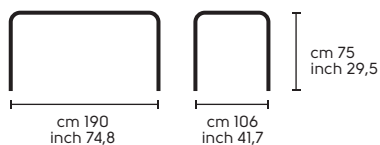

**Portofino 200x106**

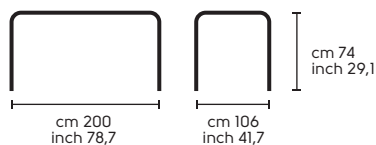

**Portofino 250x106**

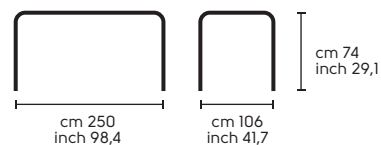

Design  
Midj R&D

# London





.02

**.01**  
LONDON tavolo fisso 200x110  
policarbonato Y04, piano vetro  
V30.

LONDON fix table 200x110  
polycarbonate Y04, glass top  
V30.

**.02**  
LONDON tavolo fisso 200x110  
policarbonato Y05, piano vetro  
VE5.

NENÈ SR-SF ecopelle 722.

LONDON fix table 200x110  
polycarbonate Y05, glass top VE5.  
NENÈ SR-SF ecoleather 722.

#### London

Tavolo ovale fisso con basamento centrale in policarbonato. Piani in cristallo. - Fixed oval table with central base in polycarbonate. Glass top - Table ovale fixe avec pied central en polycarbonate - Tisch oval, nicht ausziehbar, mit zentralem Polycarbonatfuß. Glassplatte. - Mesa ovalada fija con

base central en policarbonato. Sobre de cristal- Овальный нераздвижной стол с центральным основанием из поликарбоната. Стеклянная столешница.

#### Basamento - Base - Base - Fuss -Base- Основание

Policarbonato - Polycarbonate - Polycarbonate -  
Polycarbonat - Polycarbonato - Поликарбонат

Y05  
Bianco - White

Y04  
Nero - Black

Cuoio - Leather - Kernleder -Cuero- Кожа

Vedi campionario per scegliere il colore - Check the  
swatches for colours - Voir l'échantillon pour choisir la  
couleur - Siehe Musterkarte um die Farbe zu wählen -  
Смотреть образцы для выбора цвета

#### Piano - Top - Plateau - Platte - Sobre - Столешница

Cristallo - Glass - Verre - Glas - Verre - Стекло

VE5  
Bianco lucido extra chiaro -Extra clear glossy  
white

V04  
Nero - Black

V30  
Trasparente -Transparent

#### Dimensioni - Dimensions - Dimensions - Abmessung - Dimensiones - Размеры

##### London

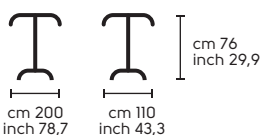

Design  
Midj R&D

# Drive





**.01.02**  
 DRIVE 120, 150, 80 acciaio R + C, piano vetro V30.  
 DRIVE 120, 150, 80 with steel frame R + C, glass top V30.

**Drive**  
 Tavolo componibile con struttura in acciaio cromato e verniciato. Piano vetro trasparente. - Modular table with chrome or painted frame. Transparent glass top. - Table modulaire avec structure chromé ou laqué. Plateau en verre transparent - Modularer Tisch mit Gestell aus verchromtem Stahl und lackiert. Boden transparentem Glas. - Mesa modular con estructura de acero cromado y pintado. Vidrio transparente Piso. - Модульная стол с хромированной стальной раме и окрашены. Этаж прозрачное стекло.

**Struttura - Frame - Structure - Gestell - Estructura - Структура**

**120x70, 150x70**

Acciaio - Steel - Acier - Stahl - Acero - Сталь

**Y**  
 Bianco - White

**R**  
 Alluminio - Aluminium

**80x80**  
**C**  
 Cromo - Chrome

**Piano - Top - Plateau - Platte - Sobre - Столешница**

Cristallo - Glass - Verre - Glas - Verre - Стекло

**V30**  
 Trasparente - Transparent

**Dimensioni - Dimensions - Dimensions - Abmessung - Dimensiones - Размеры**

**Drive 120x70**

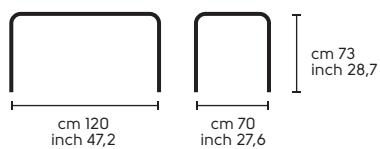

**Drive 150x70**

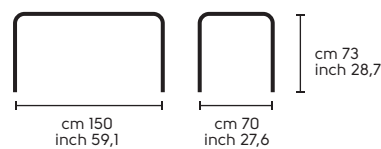

**Drive 80x80**

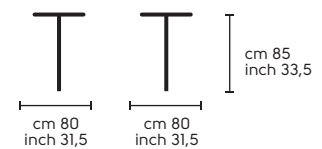

Design  
Studio Balutto associati

# Brioso









**.01 .02 .03**

BRIOSO 160x90 tavolo fisso acciaio C, piano vetro V30,  
COVER in acciaio C, pelle V18.



BRIOSO 160x90 fix table with steel frame C, glass top V30,  
COVER with steel frame C, leather V18.



**Briosio**  
 Tavolo fisso con struttura in acciaio. Piani in cristallo. - Table with metal frame. Glastop. - Table avec structure en acier. Plateau en verre. - Tisch mit Gestell aus Stahl. Glasplatte. - Mesa con estructura en acero. Sobre en verre. - Стол нераскладной со стальным каркасом и столешницей из стекла

**Struttura - Frame - Structure - Gestell - Estructura - Структура**

Acciaio - Steel - Acier - Stahl - Acero - Сталь

-  **Y**  
Bianco - White
-  **R**  
Alluminio - Aluminium
-  **C**  
Cromo - Chrome

**Piano - Top - Plateau - Platte - Sobre - Столешница**

Cristallo - Glass - Verre - Glas - Verre - Стекло

-  **V30**  
Trasparente - Transparent

**Dimensioni - Dimensions - Dimensions - Abmessung - Dimensiones - Размеры**

**Briosio 140x80**

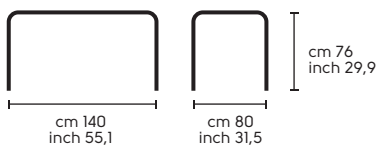

**Briosio 160x90**

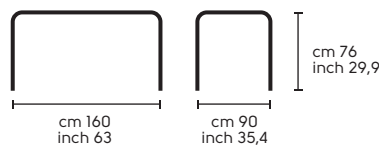

**Briosio 180x90**

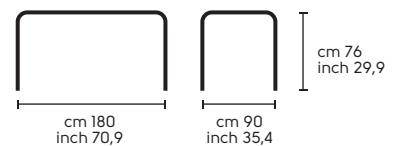

Design  
Midj R&D

# Poker



**.01**

POKER tavolo fisso 80x80 acciaio Y, piano melaminico M12, KRONO acciaio Y, tessuto 369.

POKER fix table 80x80 with steel frame Y, melamine top M12, KRONO with steel frame Y, fabric 369.

**.02**

POKER tavolo fisso 160x80 acciaio C, piano melaminico M01.

POKER fix table 160x80 with steel frame C, melamine top M01.

**.02****Poker**

Tavolo fisso con struttura in acciaio verniciato. Piano in melaminico. - Fix table with chrome or painted frame. Melamine top. - Table fixe avec structure en acier chromé ou laqué. Plateau en mélaminé. -

Tisch mit Stahlgestell. Platte aus Melamine. - Mesa con estructura en acero cromado o pintado. Sobre en melamina. - Исправлена таблица с окрашенной стали структуры. Меламин.

**Struttura - Frame - Structure - Gestell - Estructura - Структура**

Acciaio - Steel - Acier - Stahl - Acero - Сталь



**Y**  
Bianco - White



**C**  
Cromo - Chrome

**Piano - Top - Plateau - Platte - Sobre - Столешница**

Melaminico - Melamine - Mèlaminé - Melamin - Melamina - Меламин



**M01**  
Bianco - White



**M12**  
Rok - Rok

**Dimensioni - Dimensions - Dimensions - Abmessung - Dimensiones - Размеры****Poker 80x80**

cm 80  
inch 31,5



cm 80  
inch 31,5



cm 76  
inch 29,9

**Poker 90x90**

cm 90  
inch 35,4



cm 90  
inch 35,4



cm 76  
inch 29,9

**Poker 160x90**

cm 160  
inch 63



cm 90  
inch 35,4



cm 76  
inch 29,9

Design  
Studio Balutto associati

# Sintesy



**.01**  
SINTESY tavolo bistrot acciaio F, piano HPL LS4.  
SINTESY bistro table with steel frame F, top HPL LS4.

**.02**  
SINTESY tavolo bistrot acciaio Y, piano HPL LS5,  
SOFFIO rivestita in tessuto 472.  
SINTESY bistro table with steel frame Y, top HPL LS5,  
SOFFIO upholstered in fabric 472.



**Sintesy**

Basamento bistrot con struttura in acciaio verniciato. - Bistrot base with painted steel frame. - Base bistrot avec structure en acier laqué. - Basis Bistro mit lackiertem Stahl. - Base bistrot con estructura en acero pintado. - контрактной основе с краской стальной раме.

**Struttura - Frame - Structure - Gestell - Estructura - Структура**

Acciaio - Steel - Acier - Stahl - Acero - Сталь



**Piani - Top - Plateau - Platte - Sobre - Столешница**

Vedi campionario per scegliere il colore - Check the swatches for colours - Voir l'échantillon pour choisir la couleur - Siehe Musterkarte um die Farbe zu wählen - Смотреть образцы для выбора цвета.

**Dimensioni - Dimensions - Dimensions - Abmessung - Dimensiones - Размеры**

**Sintesy**

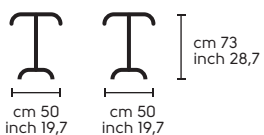

Design  
Midj R&D

# Four





**.01**  
FOUR tavolo bistrot acciaio C, piano HPL LS4.  
FOUR bistro table with steel frame C, top HPL LS4.

**.02**  
FOUR tavolo bistrot acciaio C, piano L40.  
FOUR bistro table with steel frame C, top L40.



**Four**  
Basamento bistrot con struttura in acciaio cromato. - Bistrot base with chrome steel frame. - Base bistrot avec structure en acier chromé. - Basement Bistro mit Gestell aus verchromtem Stahl. - Base bistrot con estructura en acero cromado. - Базовому контракту с хромированной стальной раме.

**Struttura - Frame - Structure - Gestell - Estructura - Структура**

Acciaio - Steel - Acier - Stahl - Acero - Сталь



**C**  
Cromo - Chrome

**Piani - Top - Plateau - Platte - Sobre - Столешница**

Vedi campionario per scegliere il colore - Check the swatches for colours - Voir l'échantillon pour choisir la couleur - Siehe Musterkarte um die Farbe zu wählen - Смотреть образцы для выбора цвета.

**Dimensioni - Dimensions - Dimensions - Abmessung - Dimensiones - Размеры**

**Four**

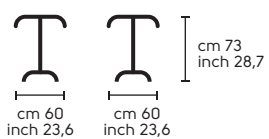

Design  
Roberto Paoli

# Trampoliere



.01

TRAMPOLIERE H110 tavolo bistrot acciaio Y, piano HPL LS5,  
TRAMPOLIERE H76 tavolo bistrot acciaio Y, piano HPL LS4.  
TRAMPOLIERE H110 bistro table with steel frame Y, top HPL LS5,  
TRAMPOLIERE H76 bistro table with steel frame Y, top HPL LS4.

.02

TRAMPOLIERE H76 tavolo bistrot acciaio Y, piano HPL LS5,  
TRAMPOLIERE sedia acciaio Y, tessuto 37A.  
TRAMPOLIERE H76 bistro table with steel frame Y, top HPL LS5,  
TRAMPOLIERE chair with steel frame Y, fabric 37A.



#### Trampoliere

Basamento bistrot con struttura in acciaio verniciato. - Bistro base with painted steel frame. - Base bistrot avec structure en acier laqué. - Basis Bistro mit lackiertem Stahl. - Base bistrot con estructura en acero pintado. - контрактной основе с краской стальной раме.

#### Struttura - Frame - Structure - Gestell - Estructura - Структура

Acciaio - Steel - Acier - Stahl - Acero - Сталь



Y  
Bianco - White



C  
Cromo - Chrome

#### Piani - Top - Plateau - Platte - Sobre - Столешница

Vedi campionario per scegliere il colore - Check the swatches for colours - Voir l'échantillon pour choisir la couleur - Siehe Musterkarte um die Farbe zu wählen - Смотреть образцы для выбора цвета.

#### Dimensioni - Dimensions - Dimensions - Abmessung - Dimensiones - Размеры

##### Trampoliere h73

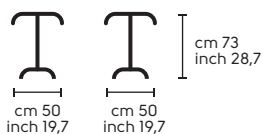

##### Trampoliere h107

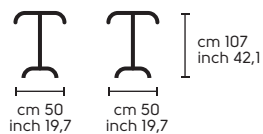

Design  
Midj R&D

# Italia



.01

ITALIA tavolo bistrot acciaio Y, piano HPL LS5,  
ITALIA tavolo bistrot acciaio C, piano HPL LS4.

ITALIA bistro table with steel frame Y, top HPL LS5,  
ITALIA bistro table with steel frame C, top HPL LS4.

.02

ITALIA tavolo bistrot acciaio C, piano HPL LS4,  
ITALIA T sedia acciaio C, ecopelle 726.

ITALIA bistro table with steel frame C, top HPL LS4,  
ITALIA T chair with steel frame C, ecoleather 726.



#### Italia

Basamento bistrot con struttura in acciaio verniciato. - Bistro base with painted steel frame. - Base bistrot avec structure en acier laqué. - Basis Bistro mit lackiertem Stahl. - Base bistrot con estructura en acero pintado. - контрактной основе с краской стальной раме.

#### Struttura - Frame - Structure - Gestell - Estructura - Структура

Acciaio - Steel - Acier - Stahl - Acero - Сталь



**Y**  
Bianco - White



**F**  
Nero - Black



**C**  
Cromo - Chrome

#### Piani - Top - Plateau - Platte - Sobre - Столешница

Vedi campionario per scegliere il colore - Check the swatches for colours - Voir l'échantillon pour choisir la couleur - Siehe Musterkarte um die Farbe zu wählen - Смотреть образцы для выбора цвета.

#### Dimensioni - Dimensions - Dimensions - Abmessung - Dimensiones - Размеры

Italia



cm 60  
inch 23,6



cm 60  
inch 23,6

cm 73  
inch 28,7

Design  
Midj R&D

# Break



**.01**

BREAK/3 tavolo bistrot acciaio C, piano HPL LS5,  
 BREAK/4 tavolo bistrot acciaio C, piano HPL, LS4.  
 BREAK/3 bistro table with steel frame C, top HPL LS5,  
 BREAK/4 bistro table with steel frame C, top HPL, LS4.

**.02**

BREAK/3 tavolo bistrot acciaio Y, piano HPL LS5,  
 CITY in acciaio Y, plastica P05.  
 BREAK/3 bistro table with steel frame Y, top HPL LS5,  
 CITY with steel frame Y, plastic P05.

**Break**

Basamento bistrot con struttura in acciaio verniciato. Bistrot base with painted steel frame. - Base bistrot avec structure en acier laqué. - Bistrot Basis mit lackiertem Metall - Base bistrot con estructura de metal pintado - Подвал бистро с окрашенной стальной конструкции.

**Struttura - Frame - Structure - Gestell - Estructura - Структура**

Acciaio - Steel - Acier - Stahl - Acero - Сталь

**Y**  
 Bianco - White

**F**  
 Nero - Black

**C**  
 Cromo - Chrome

**Piani - Top - Plateau - Platte - Sobre - Столешница**

Vedi campionario per scegliere il colore - Check the swatches for colours - Voir l'échantillon pour choisir la couleur - Siehe Musterkarte um die Farbe zu wählen - Смотреть образцы для выбора цвета.

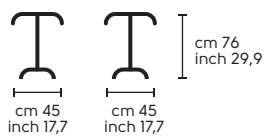
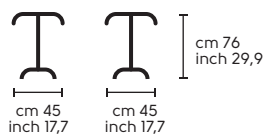
**Dimensioni - Dimensions - Dimensions - Abmessung - Dimensiones - Размеры****Break 3****Break 4**

Design  
Midj R&D

# Infinity









**.01**  
 INFINITY basamento bistrot Ø120 acciaio C,  
 piano vetro V30,  
 TWIST S acciaio C, ecopelle 737.  
 INFINITY bistro base Ø120 with steel frame  
 C, glass top V30,  
 TWIST S with steel frame C, ecoleather 737.

**.02**  
 INFINITY basamento bistrot Ø100 acciaio C,  
 piano vetro VE5,  
 GUAPA S acciaio Y, cuoio tk U22, U18.  
 INFINITY bistro base Ø100 with steel frame C,  
 glass top VE5,  
 GUAPA S with steel frame Y, tk hide U22, U18.

**.03**  
 INFINITY basamento bistrot Ø100 acciaio C,  
 piano vetro V30.  
 INFINITY bistro base Ø100 with steel frame C,  
 glass top V30.



**Infinity**

Tavolo fisso con struttura in acciaio. Piani in cristallo. Fix table with metal frame. Glasstop. - Table avec structure en acier. Plateau en verre. - Tisch mit Stahlgestell. Platte aus Glas. - Mesa con estructura en acero. Sobre en cristal. - Стол нераскладной со стальным каркасом и столешницей из стекла.

**Struttura - Frame - Structure - Gestell - Estructura - Структура**

Acciaio - Steel - Acier - Stahl - Acero - Сталь

**Y**  
 Bianco - White

**R**  
 Alluminio - Aluminium

**C**  
 Cromo - Chrome

**Piani - Top - Plateau - Platte - Sobre - Столешница**

Vedi campionario per scegliere il colore - Check the swatches for colours - Voir l'échantillon pour choisir la couleur - Siehe Musterkarte um die Farbe zu wählen - Смотреть образцы для выбора цвета.

**Dimensioni - Dimensions - Dimensions - Abmessung - Dimensiones - Размеры**

**Infinity Ø60 h51**

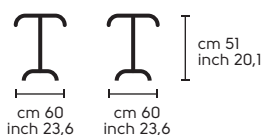

**Infinity Ø60 h76**

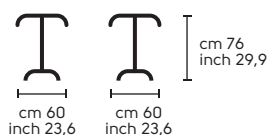

**Infinity Ø80**

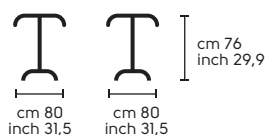

**Infinity Ø100**

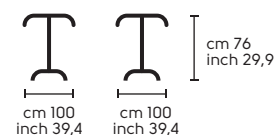

**Infinity Ø120**

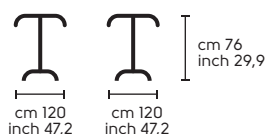

Design  
Walter Hösel

# Face



.01

FACE H110 tavolo bistrot acciaio C, piano  
vetro V30.

FACE H110 bistro table with steel frame C,  
glass top V30.



**Face**

Basamento bistrot con struttura in acciaio verniciato. - Bistrot base with painted steel frame. - Base bistrot avec structure en acier laqué. - Basis Bistro mit lackiertem Stahl. - Base bistrot con estructura

en acero pintado. - База бистро со структурой окрашенной стали. ержавеющей стали. Древесина колонка.

**Struttura - Frame - Structure - Gestell - Estructura - Структура**

Acciaio - Steel - Acier - Stahl - Acero - Сталь



**Y**  
Bianco - White



**R**  
Alluminio - Aluminium



**C**  
Cromo - Chrome

**Piani - Top - Plateau - Platte - Sobre - Столешница**

Vedi campionario per scegliere il colore - Check the swatches for colours - Voir l'échantillon pour choisir la couleur - Siehe Musterkarte um die Farbe zu wählen - Смотреть образцы для выбора цвета.

**Dimensioni - Dimensions - Dimensions - Abmessung - Dimensiones - Размеры**

**Face h48**

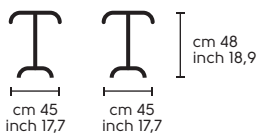

**Face h73**

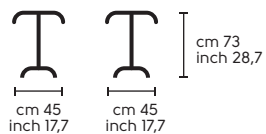

**Face h107**

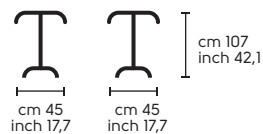

Design  
Midj R&D

# Composit





**.01**  
 COMPOSIT/2 acciaio C, piano HPL LS5,  
 SILVY S-A acciaio c, tessuto 376.  
 COMPOSIT/2 acciaio C, piano HPL LS5,  
 SILVY S-A with steel frame c, fabric 376.

**.02**  
 COMPOSIT/3 acciaio Y, piano HPL LS5,  
 TWIST I acciaio Y, Hirek HR5.  
 COMPOSIT/3 with steel frame Y, HPL top LS5,  
 TWIST I with steel frame Y, Hirek HR5.



.03  
COMPOSIT 4 acciaio C + legno L40, piano vetro V30.  
COMPOSIT 4 with steel frame C + wood L40, glass top V30.





Composit 1



Composit 2



Composit 3



Composit 4

**Composit 1/2/3**

Basamento bistrot con struttura in acciaio verniciato o inox. - Bistrot base with painted steel or stainless steel frame. - Bistrot base avec structure en acier laqué ou inoxydable. - Basement Bistro mit lackiertem Stahl oder Edelstahl. - Base bistrot con estructura en acero pintado o acero inoxidable. Подвал бистро с окрашенной или нержавеющей стали.

**Composit 4**

Basamento bistrot con struttura in acciaio verniciato o inox. Colonna in legno. - Bistrot base with painted steel or stainless steel frame. Wooden column. - Base bistrot avec structure en acier laqué ou inoxydable. Colonne en bois. - Basement Bistro mit lackiertem Stahl oder Edelstahl. Holz Spalte. - Base bistrot con estructura en acero pintado o acero inoxidable. Columna en madera. - Подвал бистро с окрашенной или нержавеющей стали. Древесина колонка.

**Struttura - Frame - Structure - Gestell - Estructura - Структура**

Acciaio - Steel - Acier - Stahl - Acero - Сталь

-  **Y** Bianco - White
-  **F** Nero - Black
-  **C** Cromo - Chrome

**Piani - Top - Plateau - Platte - Sobre - Столешница**

Vedi campionario per scegliere il colore - Check the swatches for colours - Voir l'échantillon pour choisir la couleur - Siehe Musterkarte um die Farbe zu wählen - Смотреть образцы для выбора цвета.

**Dimensioni - Dimensions - Dimensions - Abmessung - Dimensiones - Размеры**

**Composit 1, 2, 3 h76**

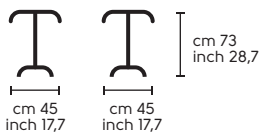

**Composit 1, 2, 3 h76**

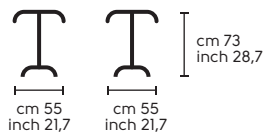

**Composit 1,2,3 h110**

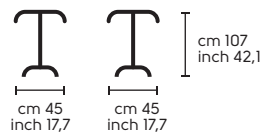

**Composit 1,2,3 h110**

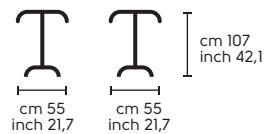

**Composit 4 h76**

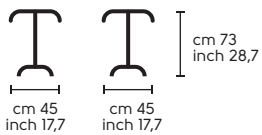

**Composit 4 h76**

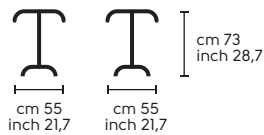

Design  
Midj R&D

# Smart





**.01**  
SMART/2 tavolo bistrot Ø42 acciaio Y, piano HPL LS5,  
RAFF S acciaio Y, baydur P18.  
SMART/2 bistro table Ø42 with steel frame Y, top HPL LS5,  
RAFF S with steel frame Y, baydur P18.

**.02**  
SMART/2 tavolo bistrot Ø42 acciaio Y, piano HPL LS5,  
NENÈ S polipropilene P08.  
SMART/2 bistro table Ø42 with steel frame Y, top HPL LS5,  
NENÈ S polypropylene P08.



**.03**  
SMART/2 tavolo bistrot Ø42 acciaio Y, piano HPL LS5,  
NENÈ S polipropilene P05 e P07.  
SMART/2 bistro table Ø42 acciaio Y, piano HPL LS5,  
NENÈ S polypropylene P05 e P07.



**Smart**  
 Basamento bistrot con struttura in acciaio verniciato o inox. - Bistro base with painted steel frame.  
 Steel or stainless steel top. Base bistrot avec structure en acier laqué ou inoxydable - Basement Bistro  
 mit lackiertem Stahl. - Base bistrot con estructura de acero pintado. - Подвал бистро с окрашенной или нержавеющей стали.

**Struttura - Frame - Structure - Gestell - Estructura - Структура**

Acciaio - Steel - Acier - Stahl - Acero - Сталь

-  **Y**  
Bianco - White
-  **F**  
Nero - Black
-  **K**  
Satinato-Satin

**Piani - Top - Plateau - Platte - Sobre - Столешница**

Vedi campionario per scegliere il colore - Check the swatches for colours - Voir l'échantillon pour choisir la couleur - Siehe Musterkarte um die Farbe zu wählen - Смотреть образцы для выбора цвета.

**Dimensioni - Dimensions - Dimensions - Abmessung - Dimensiones - Размеры**

**Smart/1 39x39 h73**

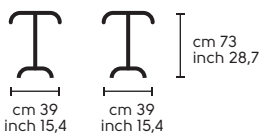

**Smart/1 39x39 h107**

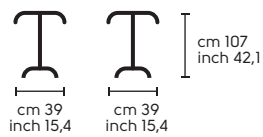

**Smart/1 48x48 h73**

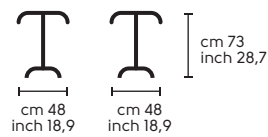

**Smart/2 ø42 h73**

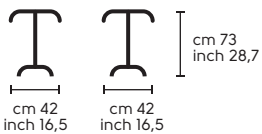

**Smart/2 ø42 h107**

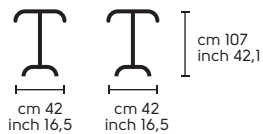

**Smart/2 ø50 h73**

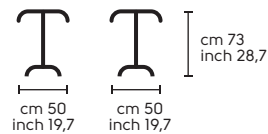

Design  
Stefano Spessotto

Dj



.01

DJ coffee table Ø80 acciaio C, cuoio U05.

DJ coffee table Ø80 with steel frame C, hide U05.

.02

DJ coffee table Ø60, Ø80, Ø100 acciaio C, cuoio U22.

DJ coffee table Ø60, Ø80, Ø100 with steel frame C, hide U22.



.02

Dj

Tavolo fisso con struttura in acciaio cromato. Piano rivestito. - Fix table with chrome frame. Hide top - Table fixe avec structure en acier chromé. Plateau en cuir. - Tisch mit Verchromt Gestell. Platte aus Glas. - Mesa con estructura en acero cromado. Sobre en cuero. - Исправлена таблица со структурой в хромированном корпусе или окрашенные. Кожа сверху.

**Struttura - Frame - Structure - Gestell - Estructura - Структура**

Acciaio - Steel - Acier - Stahl - Acero - Сталь



**C**  
Cromo - Chrome

**Piano - Top - Plateau - Platte - Sobre - Столешница**

Cuoio - Hide - Cuir - Kernleder - Cuero -  
Натуральная Кожа

Cuoio rigenerato - Rogenerated hide - Cuir régénéré -  
Rigeneriertes leder - Cuero regenerado - Регенерированная  
Кожа

Vedi campionario per scegliere il colore - Check the  
swatches for colours - Voir l'échantillon pour choisir la  
couleur - Siehe Musterkarte um die Farbe zu wählen -  
Смотреть образцы для выбора цвета

**Dimensioni - Dimensions - Dimensions - Abmessung - Dimensiones - Размеры**

Dj Ø 60

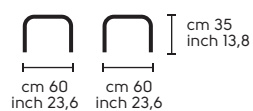

Dj Ø 80

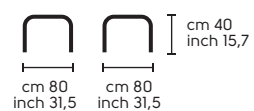

Dj Ø 100

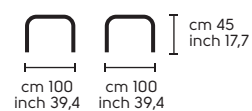

Design  
Walter Hösel

# Walter





**.01**  
 WALTER 60x40 coffee table acciaio C.  
 WALTER 60x40 coffee table with steel frame C.

**.02**  
 WALTER 40x40 coffee table acciaio Y,  
 WALTER 60x40 coffee table acciaio Y.  
 WALTER 40x40 coffee table with steel frame Y,  
 WALTER 60x40 coffee table with steel frame Y.



**Walter**  
 Tavolo fisso con struttura in acciaio. Piano in acciaio inox satinato. - Fix table with steel frame. Top in stainless steel. - Table fixe avec structure en acier. Plateau en acier inoxydable. - Fester Tisch mit lackierter Stahlstruktur. Top aus gebürstetem Edelstahl. - Mesa con estructura en acero pintado.

Sobre en acero inoxidable cepillado. - Исправлена таблица с окрашенной стали структуры. Top матовой нержавеющей стали.

**Struttura - Frame - Structure - Gestell - Estructura - Структура**

Acciaio - Steel - Acier - Stahl - Acero - Сталь



**Piano - Top - Plateau - Platte - Sobre - Столешница**

Acciaio - Steel - Acier - Stahl - Acero - Сталь



**Dimensioni - Dimensions - Dimensions - Abmessung - Dimensiones - Размеры**

**Walter 40x40**

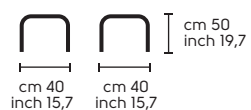

**Walter 60x40**



Design  
sempere#poli

# Guapa



.01

GUAPA CT-S, CT-M, CT-L coffee table acciaio Y, cuoio U66.

GUAPA CT-S, CT-M, CT-L coffee table with steel frame Y, cuoio U66.

.02.03

GUAPA CT-S, CT-M, CT-L coffee table acciaio Y, cuoio U05.

GUAPA CT-S, CT-M, CT-L coffee table with steel frame Y, cuoio U05.



.02



.03

### Guapa

Tavolo fisso con struttura in acciaio cromato o verniciato. Piano in cuoio. - Fix table with chrome or painted frame. Hide top - Table fixe avec structure en acier chromé ou laqué. Plateau en cuir. - Tisch

mit Stahlgestell. Platte aus Glas. - Mesa con estructura en acero cromado o pintado. Sobre en cuero. Исправлена таблица со структурой в хромированном корпусе или окрашенные. Кожа сверху.

### Struttura - Frame - Structure - Gestell - Estructura - Структура

Acciaio - Steel - Acier - Stahl - Acero - Сталь



**C**  
Cromo - Chrome



**Z**  
Nichel nero - Black nickel



**Y**  
Bianco - White

### Piano - Top - Plateau - Platte - Sobre - Столешница

Cuoio - Hide - Cuir - Kernleder - Cuero -  
Натуральная Кожа

Vedi campionario per scegliere il colore - Check the swatches for colours - Voir l'échantillon pour choisir la couleur - Siehe Musterkarte um die Farbe zu wählen - Смотреть образцы для выбора цвета

### Dimensioni - Dimensions - Dimensions - Abmessung - Dimensiones - Размеры

#### Guapa CT-S

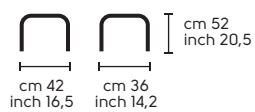

#### Guapa CT-M

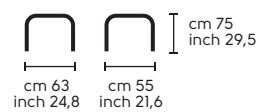

#### Guapa CT-L

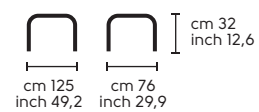

Design  
Beatriz Sempere  
Apelle



.01

APELLE CT coffee table acciaio C, cuoio U64.

APELLE CT coffee table with steel frame C, hide U64.

.02

APELLE CT coffee table acciaio Z, cuoio U65,  
APELLE DN dondolo acciaio Z, cuoio U65.

APELLE CT coffee table with steel frame Z, hide U65,

APELLE DN rocking chair with steel frame Z, hide U65.



.02

**Apelle CT**

Tavolo fisso con struttura in acciaio cromato o verniciato. Piano in cuoio. - Fix table with chrome or painted frame. Hide top - Table fixe avec structure en acier chromé ou laqué. Plateau en cuir. - Fester Tisch mit Gestell aus verchromtem oder gemalt. Platte aus Leder. - Mesa fija con estructura en acero

cromato o pintado. Sobre en cuero. - Исправлена таблица со структурой в хромированном корпусе или окрашенные. Кожа сверху.

**Struttura - Frame - Structure - Gestell - Estructura - Структура**

Acciaio - Steel - Acier - Stahl - Acero - Сталь

**Y**  
Bianco - White

**C**  
Cromo - Chrome

**Z**  
Nichel nero - Black nickel

**R**  
Oro rosa - Pink gold

**Piano - Top - Plateau - Platte - Sobre - Столешница**

Cuoio - Hide - Cuir - Kernleder - Cuero -  
Натуральная Кожа

Vedi campionario per scegliere il colore - Check the swatches for colours - Voir l'échantillon pour choisir la couleur - Siehe Musterkarte um die Farbe zu wählen - Смотреть образцы для выбора цвета

**Dimensioni - Dimensions - Dimensions - Abmessung - Dimensiones - Размеры**

**Apelle CT**



Design  
Midj R&D

# Joint



**.01**  
 JOINT H60 e H35 acciaio Z, cuoio U53,  
 AFRA DIV divano acciaio Z, tessuto "pied de poule".  
 JOINT H60 and H35 with steel frame Z, hide U53,  
 AFRA DIV sofa with steel frame Z, fabric "pied de poule"

**.02**  
 Joint H35 e H60 acciaio Z, cuoio U53.  
 Joint H35 and H60 with steel frame Z, hide U53.

**.02**



**Joint**  
 Tavolo fisso con struttura in acciaio cromato. Piano in cuoio. - Fix table with chrome frame. Hide top -  
 Table fixe avec structure en acier chromé. Plateau en cuir. - Tisch mit Stahlgestell. Platte aus Glas.

- Mesa con estructura en acero cromado. Sobre en cuero. - Исправлена стол с хромированной  
 стальной раме. Кожа сверху.

**Struttura - Frame - Structure - Gestell - Estructura -  
 Структура**

Acciaio - Steel - Acier - Stahl - Acero - Сталь



**C**  
 Cromo - Chrome



**Z**  
 Nichel nero - Black nickel

**Piano - Top - Plateau - Platte - Sobre - Столешница**

Cuoio - Hide - Cuir - Kernleder - Cuero -  
 Натуральная Кожа

Cuoio rigenerato - Rogenerated hide - Cuir régénéré  
 - Regeneriertes leder - Cuero regenerado -  
 Регенерированная Кожа

Vedi campionario per scegliere il colore - Check the  
 swatches for colours - Voir l'échantillon pour choisir la  
 couleur - Siehe Musterkarte um die Farbe zu wählen -  
 Смотреть образцы для выбора цвета

**Dimensioni - Dimensions - Dimensions - Abmessung - Dimensiones - Размеры**

**Joint h60**



**Joint h35**



Design  
Paolo Vernier  
Trip





**.01**

TRIP H45 coffee table acciaio F, cuoio U54,  
TRIP H50 coffee table acciaio F, cuoio U53,  
TRIP H60 coffee table acciaio F, cuoio U18.

TRIP H45 coffee table with steel frame F, hide U54,  
TRIP H50 coffee table with steel frame F, hide U53,  
TRIP H60 coffee table with steel frame F, hide U18.

**.02**

TRIP H45 coffee table acciaio F, cuoio U66,  
TRIP H50 coffee table acciaio F, cuoio U69,  
TRIP H60 coffee table acciaio F, cuoio U68.

TRIP H45 coffee table with steel frame F, hide U66,  
TRIP H50 coffee table with steel frame F, hide U69,  
TRIP H60 coffee table with steel frame F, hide U68.

**.02****Trip**

Tavolo fisso con struttura in acciaio verniciato. Piano in cuoio. - Fix table with chrome or painted frame. Hide top - Table fixe avec structure en acier chromé ou laqué. Plateau en cuir. - Tisch mit Stahlgestell.

Platte aus Glas. - Mesa con estructura en acero cromado o pintado. Sobre en cuero. Исправлена таблица с окрашенной стали структуры. Кожа сверху.

**Struttura - Frame - Structure - Gestell - Estructura - Структура**

Acciaio - Steel - Acier - Stahl - Acero - Сталь

**Piano - Top - Plateau - Platte - Sobre - Столешница**

Cuoio rigenerato - Rogenerated hide - Cuir régénéré  
- Regeneriertes leder - Cuero regenerado -  
Регенерированная Кожа

Vedi campionario per scegliere il colore - Check the  
swatches for colours - Voir l'échantillon pour choisir la  
couleur - Siehe Musterkarte um die Farbe zu wählen -  
Смотреть образцы для выбора цвета

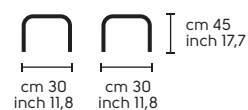
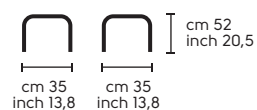
**Dimensioni - Dimensions - Dimensions - Abmessung - Dimensiones - Размеры****Trip h45****Trip h50****Trip h60**







.02

**.01 .02**  
GEOFFREY carrello in acciaio Y  
GEOFFREY cart with steel frame Y.

**.03**  
KIT TAVOLETTA in plastica P04.  
KIT DESK in plastic P04.

**.04**  
KIT PORTA DOCUMENTI in acciaio C.  
KIT PORTFOLIO with steel frame C.

**.05**  
KIT GANCI UNIONE in acciaio C.  
KIT UNION HOOK with steel frame C.



.03



.04



.05









#### **Espositore**

Espositore per sedie con struttura modulare in acciaio laccato bianco. Ripiani superiori in vetro trasparente. Ripiani inferiori in vetro acidato. - Chairs display with modular structure in white painted steel. Upper shelves in transparent glass. Lower shelves in frosted glass. - Exposer pour chaises avec une structure modulaire en acier laqué blanc. Étagères supérieures en verre transparent. Étagères inférieures en verre dépoli. - Stuhlregal mit Modulgestell aus weiß lackiertem Stahl. Obere Regale aus transparentem Glass. Untere Regale aus geätzttem Glass. - Expositor para sillas con estructura modular en acero lacado blanco. Estantes superiores en cristal transparente. Estantes inferiores en vidrio esmerilado. - Экспозитор для стульев с модульной

структурой из окрашенной в белый цвет стали. Верхние полки – из прозрачного стекла. Нижние полки – из окисленного стекла.



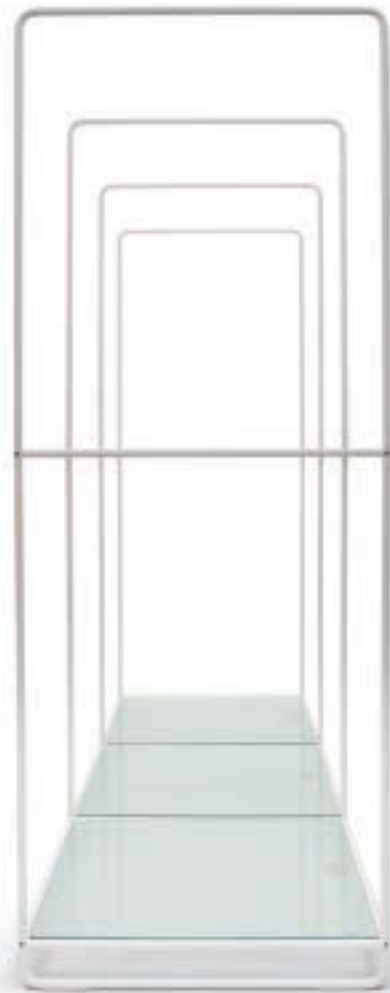

## Modulo

Dimensioni - Dimensions - Dimensions - Abmessung - Dimensiones - Размеры  
 cm L74xP74xH200  
 inch L29,1xW29,1xH78,7

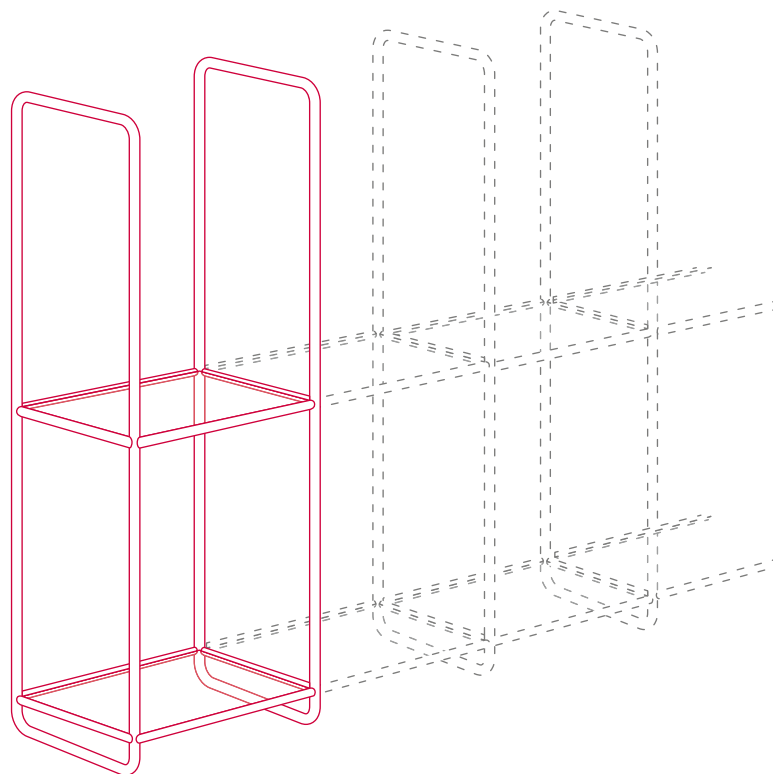
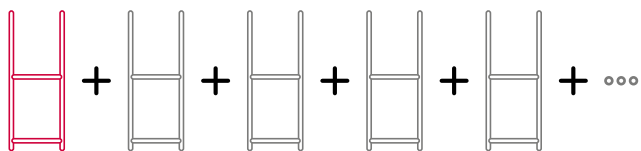



## Banner

Dimensioni - Dimensions - Dimensions - Abmessung - Dimensiones - Размеры

cm L74xP25xH200  
inch L29,1xW9,8xH78,7







# Cuoio - Hide

---



**U68**  
Verde pino  
Pine green



\* **U69**  
Verde salvia  
Sage green



\* **U66**  
Azzurro  
Light blue



\* **U67**  
Blu oceano  
Ocean blue

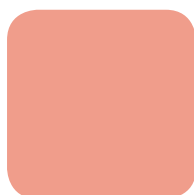

**U65**  
Rosa  
pompelmo  
Grapefruit  
pink

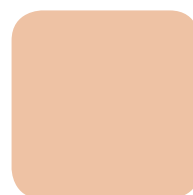

**U64**  
Rosa cipria  
Facepowder pink

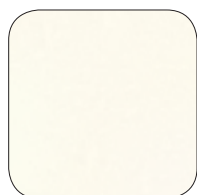

\* **U05**  
Bianco  
White



**U34**  
Vaniglia  
Vanilla



\* **U22**  
Odra  
Ocher



**U21**  
Arancio  
Orange



\* **U42**  
Rosso  
Red



**U01**  
Rosso Bulgaro  
Red Bulgaro



\* **U18**  
Grigio cenere  
Ash grey



**U53**  
Avana  
Havana



**U25**  
Caffè  
Coffee



**U02**  
Grigio scuro  
Dark grey



\* **U54**  
Fango  
Fango



**U41**  
Testa di moro  
Dark brown



\* **U04**  
Nero  
Black

\* Modello GUAPA disponibile solo in questi colori. - GUAPA models available only in this colors.

# Cuoio rigenerato - Rigenerated hide

---



**Z05**  
Bianco  
White



**Z34**  
Vaniglia  
Vanilla



**Z22**  
Ocra  
Ocher



**Z41**  
Testa di moro  
Dark brown



**Z01**  
Rosso Bulgaro  
Red Bulgaro



**Z42**  
Rosso  
Red



**Z02**  
Grigio scuro  
Dark grey



**Z53**  
Avana  
Havana



**Z18**  
Grigio cenere  
Ash grey



**Z04**  
Nero  
Black

# Pelle fiore - Fiore leather

---



**F05**  
Bianco  
White



**F09**  
Sky  
Sky



**F38**  
Denim  
Denim



**F01**  
Bordeaux  
Bordeaux



**F42**  
Rosso  
Red



**F51**  
Verde oliva  
Olive green



**F22**  
Ocra  
Ocher



**F34**  
Vaniglia  
Vanilla



**F20**  
Fumo  
Smoke



**F41**  
Testa di moro  
Dark brown



**F25**  
Caffè  
Coffee



**F54**  
Fango  
Fango



**F04**  
Nero  
Black



**F03**  
Grigio polvere  
Dust grey



**F18**  
Grigio cenere  
Ash gray



# Pelle special - Special leather

---



**E42**  
Rosso  
Red



**E22**  
Ocra  
Ocher



**E34**  
Vaniglia  
Vanilla



**E05**  
Bianco  
White



**E18**  
Grigio cenere  
Ash gray



**E03**  
Grigio polvere  
Dust grey



**E41**  
Testa di moro  
Dark brown



**E04**  
Nero  
Black

# Pelle vintage - Vintage leather

---



**V18**  
Grigio cenere  
Ash grey



**V02**  
Grigio  
Grey



**V41**  
Cioccolato  
Chocolate



**V11**  
Cuoio  
Hide

# Ecopelle vintage - Vintage ecoleather Cat. A

---



**7V8**  
Grigio cenere  
Ash grey



**7V2**  
Grigio  
Grey

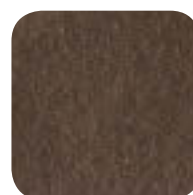

**7V4**  
Cioccolato  
Chocolate



**7V1**  
Cuoio  
Hide

# Trapuntato - Quilted

---



**710**  
Bianco  
White



**709**  
Catrame  
Catrame



**708**  
Cemento  
Cemento

# Elastico - Elastic

---



**EL3**  
Perla  
Perla



**EL4**  
Nero  
Black



**EL7**  
Lilla  
Liliac

# Rete - Mesh

---



**R02**  
Grigio/bianco  
Grey/white

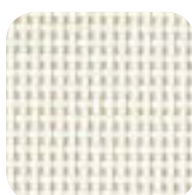

**R05**  
Bianco  
White



**R07**  
Sabbia  
Sand

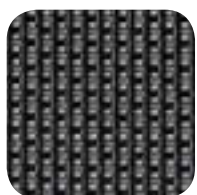

**R04**  
Nero  
Black



**669**  
Azzurro  
Light blue



**662**  
Blu  
Blue



**648**  
Viola  
Violet



**667**  
Arancio  
Orange



**653**  
Rosso  
Red



**651**  
Rosso Bulgaro  
Red Bulgaro



**664**  
Ocra  
Ocher



**668**  
Verde menta  
Mint green



**657**  
Verde pino  
Pine green



**652**  
Bianco  
White



**649**  
Beige  
Beige



**665**  
Sabbia  
Sand



**663**  
Grigio cenere  
Ash grey



**646**  
Catrame  
Catrame



**655**  
Marrone  
Brown



**645**  
Cemento  
Cemento



**650**  
Nero  
Black



**726**  
Avio  
Avio



**725**  
Jeans  
Jeans



**724**  
Viola  
Violet



**728**  
Rosso Bulgaro  
Red Bulgaro



**733**  
Rosso  
Red



**729**  
Arancio  
Orange



**734**  
Ocra  
Ocher



**737**  
Lime  
Lime



**722**  
Bianco  
White



**731**  
Avorio  
Ivory



**735**  
Sabbia  
Sand



**736**  
Tortora  
Tortora



**738**  
Grigio cenere  
Ash grey



**718**  
Grigio Polvere  
Dust Grey



**714**  
Marrone  
Brown



**742**  
Grafite  
Grafite



**730**  
Nero  
Black

# Tessuto natural wool - Natural wool fabric Cat. A

---



**452**  
Jeans  
Jeans



**462**  
Vinaccia  
Vinaccia



**472**  
Fucsia  
Fuxia



**454**  
Verde oliva  
Olive green



**468**  
Verde mela  
Apple green



**455**  
Lime  
Lime



**466**  
Marrone  
Brown



**464**  
Rosso  
Red



**456**  
Arancio  
Orange



**458**  
Castagna  
Castagna



**473**  
Grigio polvere  
Dust grey



**474**  
Beige  
Beige



**460**  
Nero  
Black



**459**  
Grigio  
Grey



**457**  
Cemento  
Cemento



**29G**  
Azzurro  
Light blue



**29F**  
Blu wawe  
Blue wawe



**29H**  
Prugna  
Prune

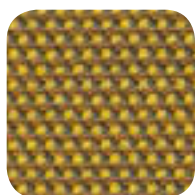

**29K**  
Giallo  
Yellow



**29J**  
Arancio  
Orange

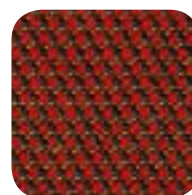

**29I**  
Rosso porpora  
Purple red

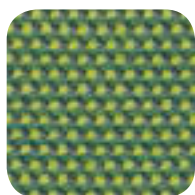

**29M**  
Verde mela  
Apple green

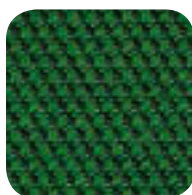

**29L**  
Verde muschio  
Muschio green

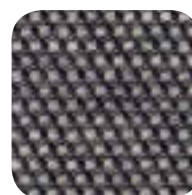

**29A**  
Pepe  
Pepper



**29C**  
Castagna  
Castagna

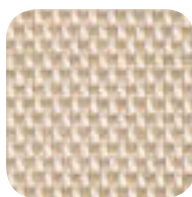

**29E**  
Sabbia  
Sand



**29B**  
Cemento  
Cemento



**29D**  
Corteccia  
Corteccia



**63N**  
Azzurro  
Light blue



**63R**  
Oltremare  
Ultramarine



**63K**  
Muschio  
Muschio



**639**  
Carminio  
Carminio



**63C**  
Glicine  
Glicine



**63B**  
Ciclamino  
Ciclamino



**638**  
Rosso  
Red



**637**  
Aragosta  
Aragosta



**635**  
Giallo  
Yellow



**631**  
Beige  
Beige



**632**  
Sabbia  
Sand



**633**  
Corteccia  
Corteccia



**63X**  
Grigio chiaro  
Light grey



**63Z**  
Grigio scuro  
Dark grey



**63G**  
Grafite  
Grafite



**63W**  
Nero  
Black





**367**  
Blu  
Blue



**372**  
Vinaccia  
Vinaccia



**368**  
Rosso scuro  
Dark red



**365**  
Arancio  
Orange



**369**  
Giallo  
Yellow



**366**  
Marrone  
Brown



**37A**  
Verde mela  
Apple green



**37B**  
Verde oliva  
Olive green



**378**  
Corteccia  
Corteccia



**376**  
Cemento  
Cemento



**375**  
Sabbia  
Sand



**371**  
Beige  
Beige



**370**  
Antracite  
Anthracite

# Plastiche - Plastics

## Polipropilene - Polypropylene

Nenè

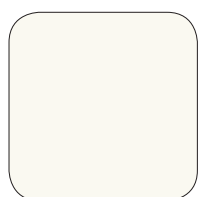

**P05**  
Bianco  
White

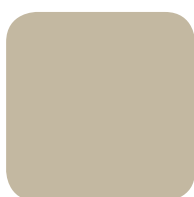

**P07**  
Sabbia  
Sand



**P06**  
Grigio cielo  
Sky grey



**P18**  
Verde  
Green

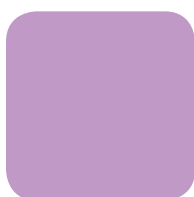

**P27**  
Lilla  
Lilac



**P08**  
Rosso  
Red



**P04**  
Nero  
Black

## Polipropilene - Polypropylene

City



**P05**  
Bianco  
White



**P02**  
Grigio  
Gray



**P04**  
Nero  
Black

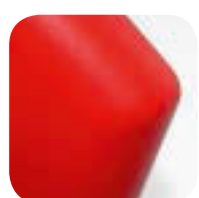

**P08**  
Rosso  
Red



**P18**  
Verde  
Green



**P27**  
Viola  
Violet

## Hirek - Hirek

Twist

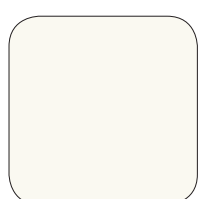

**HR5**  
Bianco  
White



**HR7**  
Sabbia  
Sand



**HR8**  
Rosso  
Red



**HR4**  
Nero  
Black

# Plastiche - Plastics

## Restylon - Restylon

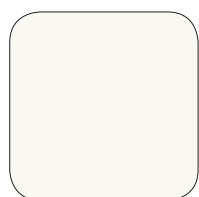

**R05**  
Bianco  
White



**R07**  
Sabbia  
Sand



**R02**  
Fango  
Fango



**R06**  
Blu  
Blue



**R08**  
Rosso  
Red



**R04**  
Nero  
Black

## Liù, Passepartout

## Baydur

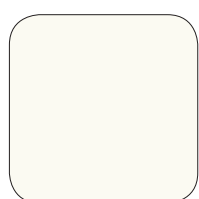

**P05**  
Bianco  
White



**P18**  
Grigio cenere  
Ash grey



**P02**  
Grigio scuro  
Dark grey



**P42**  
Rosso  
Red



**P22**  
Ocra  
Ocher



**P51**  
Verde oliva  
Olive green

## Raff

## Policarbonato lucido - Glossy polycarbonate



**H30**  
Trasparente  
Transparent



**Y05**  
Bianco  
White



**Y07**  
Sabbia  
Sand



**Y08**  
Rosso  
Red



**H08**  
Rosso  
trasparente  
Red  
transparent



**H21**  
Arancio  
trasparente  
Orange  
transparent



**H41**  
Fumè  
trasparente  
Fumè  
transparent



**Y04**  
Nero  
Black

## Zelig

# Metalli - Metals

---



**R**  
Alluminio  
Aluminium

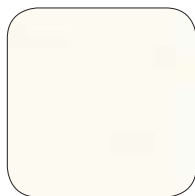

**Y**  
Bianco  
White



**S**  
Corda  
Sand



**G**  
Grafite  
Grafite



**T**  
Testa di moro  
Dark brown

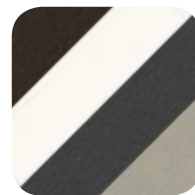

**MC**  
Multicolor  
Multicolor



**C**  
Cromo  
Chrome



**K**  
Satinato  
Satin



**D**  
Cenere  
Ash Grey



**F**  
Nero  
Black



**Z**  
Nichel nero  
Black nickel



**\*OR**  
Oro rosa  
Pink gold

\* Disponibile solo per alcuni modelli collezione Apelle - Available only for some models Apelle collection

# Cristalceramica - Crystalceramic

---



**VC3**  
Oxide bianco  
White oxide



**VC2**  
Basalto  
Basalt



**VC4**  
Piombo  
Lead

I piani in cristalceramica provengono dalla tecnologia costruttiva del gres ceramico.

Realizzati con impianti ed attrezzature molto avanzate, uniscono allo spessore ridotto, un'elevata resistenza alle sollecitazioni meccaniche, ai prodotti chimici, all'usura, ai graffi, all'abrasione e resistono al gelo ed al fuoco.

Il processo di cottura a 1200 gradi di vari impasti di argilla, sabbia, silice ed altre sostanze naturali ne garantiscono l'assoluta originalità e massima riciclaggio ambientale.

Leggerissime imperfezioni di superficie e di lievi differenze cromatiche sono da considerare elementi naturali che ne accertano l'originalità e l'autenticità del prodotto.

The tops in cristalceramic come from construction technology of ceramic stoneware.

Made with highly advanced facilities and equipment, combine to the reduced thickness, high resistance to mechanical stresses, chemical products, wear, scratches, abrasion and they are resistant to frost and fire.

The cooking process at 1200 degrees of various mixtures of clay, sand, silica and other natural substances guarantees the absolute originality and maximum environmental recycling.

Slight surface imperfections and slight color differences are considered natural elements which ensure the originality and authenticity of the product.

# Cristalli - Glasstop

---



**VE5**  
Bianco lucido  
extra chiaro  
Extra clear  
glossy white



**VA5**  
Bianco extrachiaro  
satinato antigraffio  
Extra clear matt  
white antiscratch

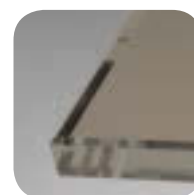

**V07**  
Corda lucido  
Glossy sand



**VA7**  
Corda satinato  
antigraffio  
Matt sand  
antiscratch



**V02**  
Grafite lucido  
Glossy grafite



**VA2**  
Grafite satinato  
antigraffio  
Matt grafite  
antiscratch



**VA8**  
Testa di moro  
satinato antigraffio  
Matt dark brown  
antiscratch



**V3E**  
Trasparente  
extra chiaro  
Extra clear  
transparent

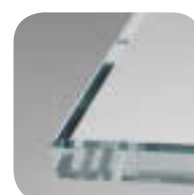

**V30**  
Trasparente  
Transparent

# Legni - Wood

---

## MDF laccato - Lacquered MDF



**D05**  
Bianco  
White



**D07**  
Corda  
Sand



**D02**  
Grafite  
Grafite



**D41**  
Testa di moro  
Dark brown

---

## Melaminico - Melamine

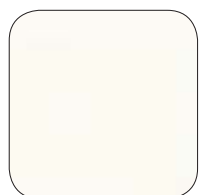

**M01**  
Bianco  
White



**M07**  
Corda  
Sand



**M02**  
Grafite  
Grafite



**M14**  
Noce  
Walnut

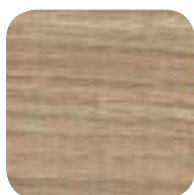

**M12**  
Rok  
Rok

---

## Impiallacciato - Veneered wood



**L40**  
Finitura rovere  
naturale  
Natural oak finish



**L26**  
Finitura rovere  
moro  
Dark oak finish



**L14**  
Finitura noce  
Walnut veneer  
finish



**L24**  
Noce fiammato  
Flamed walnut

---

## Legno - Wood



**LM1**  
Massello di noce  
corteccia - Solid  
walnut bark

# HPL

---





**LS5**  
Bianco  
White

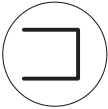

**LS4**  
Nero  
Black

# Piani tavoli - Table top

	Modelli disponibili	spessore	bordo
<b>HPL</b>			
ø60	Composit h75-h110 Smart h75-h110 Break 3-4, Infinity Italia Trampoliere h75-h110	cm 1	
ø70	Composit h75-h110 Smart h75-h110 Break 3-4 Infinity Italia Trampoliere h75	cm 1	
ø79,2	Composit h75 Smart h75 Break 4 Infinity Four	cm 1	
60x60	Composit h75-h110 Smart h75-h110 Italia Sintesy	cm 1	
70x70	Composit h75-h110 Smart h75-h110 Italia Sintesy	cm 1	
79,2x79,2	Composit h75 Smart h75 Four Sintesy	cm 1	
<b>MELAMINICO</b>			
ø60	Composit h75-h110 Smart h75-h110 Break 3-4 Infinity Italia Trampoliere h75-h110	cm 1,8/2	
ø70	Composit h75-h110 Smart h75-h110 Break 3-4 Infinity Italia Trampoliere h75	cm 1,8/2	
ø80	Composit h75 Smart h75 Break 4 Infinity Four	cm 1,8/2	
ø100	Infinity	cm 1,8/2	
ø120	Infinity	cm 1,8/2	
60x60	Composit h75-h110 Smart h75-h110 Italia Sintesy	cm 1,8/2	
70x70	Composit h75-h110 Smart h75-h110 Italia Sintesy	cm 1,8/2	
80x80	Composit h75 Smart h75 Four Sintesy	cm 1,8/2	
<b>VETRO</b>			
ø60	Composit h75-h110 Face H75-H110 Infinity	cm 1	
ø80	Composit h75 Face H75 Infinity	cm 1	
ø100	Infinity	cm 1	
ø120	Infinity	cm 1	
<b>HIREK</b>			
ø60	Composit h75-h110 Smart h75-h110 Break 3-4 Infinity Italia Trampoliere h75-h110	cm 1	
70x70	Composit h75-h110 Smart h75-h110 Break 3-4 Sintesy Italia	cm 1	





Midj si riserva la facoltà di apportare modifiche o migliorie ai prodotti illustrati in questo catalogo in qualunque momento senza l'obbligo di preavviso.

I colori dei materiali fotografati nel presente catalogo e nella cartella materiali, sono indicativi in quanto è tecnicamente impossibile riprodurre fedelmente i toni e le finiture. Midj declina ogni responsabilità per richieste di abbinamento con materiali acquistati precedentemente.

Tutti i diritti riservati

Midj reserves the right to modify or upgrade the products shown in this catalogue at any time and without prior notice.

The colors of the photographic materials in the present catalogs and in the samples materials, are indicative as it is technically impossible to reproduce the tones and finishes. Midj disclaims any responsibility for color-matching requests with previously purchased articles.

All right reserved



MIDJ srl  
Via Madonna di Campagna, 2/A  
33075 Cordovado (PN) - Italy  
T +39.0434690122  
[www.midj.it](http://www.midj.it)  
[info@midj.it](mailto:info@midj.it)

Project:	Vassalli associati
Art direction:	Gianluca Vassalli
Graphic design:	Alessandro Orteschi
Stylist:	Barbara Marsiletti
Photo:	Salmaso fotografia Emanuele Tortora
Color separation:	GM Studio 1
Print:	Sincromia COD. 150675

Thanks to:  
Ristorante "Grani di Pepe", Flaibano, Udine, Italy  
Collezione d'arte contemporanea "Punto Fermo", San Vito al Tagliamento, Pordenone, Italy  
Negozio "Scultur", San Giovanni di Casarsa, Pordenone, Italy



MIDJ<sup>®</sup>  
in Italy