



Home news 2015

MIDJ[®]
in Italy

Tavoli
Tables

Apollo LG p. 20
Badù L-XL p. 44
Klass p. 36
Pechino p. 10
Portofino p. 30

Sedie
Chairs

Apelle p. 62
Ciak p. 70
Guapa p. 56
Marilyn p. 74
Naomi p. 78
Portofino p. 68
Silvy CU p. 80
Silvy TS p. 84
Sonny p. 72

Tavoli



Pechino p. 10



Apollo LG p. 20



Portofino p. 30



Klass p. 36



Badù L-XL p. 44

Sedie



Guapa p. 56



Apelle p. 62



Portofino p. 68



Ciak p. 70



Sonny p. 72



Marilyn p. 74



Naomi p. 78



Silvy CU p. 80



Silvy TS p. 84

Soft design, happy living

Il dna della nostra produzione risiede anche nella fiducia nel futuro. Progettiamo per gente che a voglia di vivere, che vuole costruirsi uno spazio luminoso e gioioso.

Il nostro design morbido accoglie la persona con linee fluide e imbottiture morbide pensate per attimi di felicità e comfort.

The dna of our production also lies in the future's confidence. We design for people who wants to live, who wants to build a bright and joyful space. Our soft design accommodates the person with flowing lines and soft padding designed for happiness and comfort moments.



Guarda come nasce Soffio
Look how Soffio chair was born

Pechino

design StudioKappa



PECHINO Tavolo fisso acciaio G, legno corteccia LMI - Fix table-steel G, wood bark LMI

KING Sedia tessuto natural wool 457 - Chair fabric natural wool 457



PECHINO Tavolo fisso acciaio G, legno corteccia LM1 - Fix table steel G, wood bark LM1

KING Sedia tessuto natural wool 457 - Chair fabric natural wool 457



PECHINO Tavolo fisso acciaio K, legno corteccia LM1 - Fix table steel K, wood bark LM1

SHARON Sedia tessuto long lifel 371 - Chair fabric long life 371



PECHINO Tavolo all. 190/240/290x106 acciaio MC, legno L26 - Ext. table 190/240/290x106 steel MC, wood L26

SONNY P LG Sedia legno L26, tessuto natural wool 473 - Chair wood L26, fabric Natural Wool 473

SONNY S LG Sedia legno L26, tessuto natural wool 473 - Chair wood L26, fabric Natural Wool 473



PECHINO Tavolo all. 190/240/290x106 acciaio S, legno L14 - Ext. table 190/240/290x106 steel S, wood L14

GUAPA S4 Sedia acciaio Z, cuoio U69 - Chair steel Z, leather U69

GUAPA P4 Poltrona acciaio Z, cuoio U69 - Armchair steel Z, leather U69



Pechino fisso

Tavolo fisso con struttura in acciaio. Piani in: cristallo, cristallo antigraffio, impiallacciato o noce massello corteccia spessore 4 cm. - Fix table with steel base. Tops in: glossy glass, matt anti scratch glass, veneer or massive walnut wood 4cm. thickness. - Table fixe avec structure en acier. Plateaux en : verre brillant, verre satiné anti-rayures, plaqués ou noyer massif écorce épaisseur 4 cm. - Tisch mit Stahlgestell. Platte aus glänzendem, mattem kratzfestem Glas, furniertem Holz oder Nussbaum Massivholz von 4cm. - Mesa fija con estructura en acero. Sobre en cristal brillante, cristal satinado antirayaduras, madera contra chapada o madera maciza de nogal espesor 4 cm - Стол нераскладной на стальном основании. Столешницы из: глянцевого, матового устойчивого к царапинам стекла, шпона или массива ореха толщиной 4см.

Dimensioni

Dimensions - Dimensions - Abmessung - Dimensiones - Размеры

cm L200xP106xH75
inch L78,7xW41,7xH29,5



posti | seats 8

cm L250xP106xH75
inch L98,4xW41,7xH29,5



posti | seats 10

Struttura

Frame - Structure - Gestell - Estructura - Структура

Piano

Top - Plateau - Platte - Sobre - Столешница

Acciaio - Steel - Acier - Stahl - Acero - Сталь

- Y** Bianco - White
- R** Alluminio - Aluminium
- S** Corda - Corda
- G** Grafite - Grafite
- T** Testa di moro - Dark Brown
- K** Satinato - Satin
- MC** Multicolor - Multicolor

Legno - Wood - Bois - Holz - Madera - Дерево

- LM1** Massello di noce corteccia - Solid walnut bark
- Impiallacciato** - Veneered wood - Bois plaqué - Holz furniert - Madera contra-chapada - Шпон
- L14** Noce - Walnut
- L26** Rovere moro - Dark Oak
- Cristallo** - Glass - Verre - Glas - Verre - Стекло
- V3E** Trasparente extra chiaro - Extra clear transparent
- VE5** Bianco lucido extra chiaro - Extra clear glossy white
- V07** Corda lucido - Glossy sand
- V02** Grafite lucido - Glosy grafite

* Disponibile solo per versione 190x106 - Available only 190x106

- Cristallo antigraffio** - Antiscratch glass - Anti-rayures Verre - Kratzfestig Glas - Verre antirayaduras
- VA5** Bianco satinato extrachiaro antigraffio - Extra clear matt white antiscratch
- VA7** Corda satinato antigraffio - Matt sand antiscratch
- VA2** Grafite satinato antigraffio - Matt grafite antiscratch
- VA8** Testa di moro satinato antigraffio - Matt dark brown antiscratch

* Disponibile solo per versione 190x106 - Available only 190x106

Pechino allungabile

Tavolo allungabile con struttura in acciaio. Piani ed allunghe in cristallo o cristallo antigraffio. - Extendable table with metal frame. Top and extensions in glass or antiscratch glass. - Table allongeable avec structure en acier. Plateau et allonges in verre ou verre anti-rayures. - Ausziehbar Tisch mit Stahlgestell. Platte und Verlängerungen aus Glas oder kratzfestig Glas. - Mesa extensible con estructura en acero. Sobre y prolongaciones en cristal o cristal antirayaduras. - Стол раскладной со стальным каркасом. Столешница и раскладки из: стекла или устойчивого к царапинам стекла

Dimensioni

Dimensions - Dimensions - Abmessung - Dimensiones - Размеры

cm L190/240/290xP106xH75
inch L74,8/94,5/114,2xW41,7xH29,5



posti | seats 2+8+2

Struttura

Frame - Structure - Gestell - Estructura - Структура

Piano e allunghe

Top and extensions - Plateau et allonges - Platte und verlängerungen - Sobre y prolongaciones - Столешница и удлинители

Acciaio - Steel - Acier - Stahl - Acero - Сталь

- Y** Bianco - White
- R** Alluminio - Aluminium
- S** Corda - Corda
- G** Grafite - Grafite
- T** Testa di moro - Dark Brown
- K** Satinato - Satin
- MC** Multicolor - Multicolor

Impiallacciato - Veneered wood - Bois plaqué - Holz furniert - Madera contra-chapada - Шпон

- L14** Noce - Walnut
- L26** Rovere moro - Dark Oak
- Cristallo** - Glass - Verre - Glas - Verre - Стекло
- VE5** Bianco lucido extra chiaro - Extra clear glossy white
- V07** Corda lucido - Glossy sand
- V02** Grafite lucido - Glosy grafite
- Cristallo antigraffio** - Antiscratch glass - Anti-rayures Verre - Kratzfestig Glas - Verre antirayaduras
- VA5** Bianco satinato extrachiaro antigraffio - Extra clear matt white antiscratch
- VA7** Corda satinato antigraffio - Matt sand antiscratch
- VA2** Grafite satinato antigraffio - Matt grafite antiscratch
- VA8** Testa di moro satinato antigraffio - Matt dark brown antiscratch

* Disponibile solo per versione 190x106 - Available only 190x106

Apollo LG

design StudioKappa



APOLLO LG Tavolo alt. 190/240/290x90 legno L14 - Ext. table 190/240/290x90 wood L14
SOFFIO TS Sedia ecopelle vintage 7V8 - Chair ecoleather vintage 7V8



APOLLO LG Tavolo alt. 190/240/290x90 legno L14 - Ext. table 190/240/290x90 wood L14
SOFFIO TS Sedia ecopelle vintage 7V8 - Chair ecoléather vintage 7V8



APOLLO LG Tavolo all. 190/240/290x90 legno L26 - Ext. table 190/240x90 wood L26

APELLE S Sedia in acciaio Z, cuoio U22 - Chair steel Z, leather U22

APELLE P Sedia in acciaio Z, cuoio U22 - Chair steel Z, leather U22



APOLLO LG Tavolo all. legno L26 - Ext. table wood L26



APOLLO LG Tavolo all. legno L14 - Ext. table wood L14



APOLLO LG Tavolo all. 190/240/290x90 legno L14, cristalceramica VC4 - Ext. table 190/240/290x90 wood L14, cristalceramic VC4

MARILYN S-LG Sedia legno L14, ecopelle 736/ecopelle trapuntata 722 - Chair wood L14, ecoleather 736, back quilted ecoleather 722

MARILYN P-LG Sedia legno L14, ecopelle 736/ecopelle trapuntata 722 - Chair wood L14, ecoleather 736, back quilted ecoleather 722

Tavolo acciaio K, cristalceramica VC3
Table steel K, crystalceramic VC3

Tavolo acciaio K, cristalceramica VC4
Table steel K, crystalceramic VC4

Tavolo acciaio S, cristalceramica VC3
Table steel S, crystalceramic VC3



Tavolo acciaio K, legno L14
Table steel K, wood L14

Tavolo acciaio G, legno L26
Table steel G, wood L26

Tavolo legno L14
Table wood L14



Tavolo legno L14, cristallo VA5
Table wood L14, glass VA5

Tavolo legno L26, cristallo VA5
Table wood L26, glass VA5

Tavolo legno L26
Table wood L26



Apollo / Apollo LG

Tavolo allungabile con gambe in legno o alluminio. Piani impiallacciati, cristallo, cristallo antigraffio o cristalceramica. - Extendable table with legs in wood or aluminum. Top in: veneer, glossy glass, matt anti scratch glass or crystal ceramic. - Table extensible avec pieds bois ou aluminium. Plateaux plaqués, verre brillant, verre satiné anti-rayures ou cristal-céramique

- Ausziehtisch mit Holz- oder Aluminiumfüßen. Platte aus furniertem Holz, glänzendem Glass, mattem kratzfestem Glass oder Cristal Keramik. - Mesa extensible con patas de madera y aluminio. Sobre en madera contra-chapada, cristal brillante, cristal satinado antirayaduras o cristal de ceramica - Раскладной стол с ножками из шпона или алюминия. Столешницы из шпона, глянцевого стекла, матового устойчивого к царапинам стекла, стеклокерамики.

Dimensioni

Dimensions - Dimensions - Abmessung - Dimensiones - Размеры

cm L140/190xP90xH75
inch L55,1/74,8xW35,4xH29,5



posti | seats 6+2

cm L160/210/260xP90xH75
inch L63/82,7/102,4xW35,4xH29,5



posti | seats 6+2+2

cm L190/240/290xP90xH75
inch L74,8/94,5/114,2xW35,4xH29,5



posti | seats 8+2+2

Struttura

Frame - Structure - Gestell - Estructura - Структура

Piano e allunghe

top and extensions - plateau et allonges - platte und verlängerungen - sobre y prolongaciones - столешница и удлинители

Piano

Top - Plateau - Platte - Sobre - Столешница

Allunghe piani Cristallo e Cristalceramica

Extensions for glass and Crystalceramic top - Allonges pour plateau en verre et Cristal Ceramic - Verlängerungen Für Glas Und Cristal Keramikplatte - Prolongaciones para sobre en verre y Cristal De Ceramica - Удлинители столешниц из стекла и стеклокерамики

Impiallacciato - Veneered wood - Bois plaqué - Holz furniert - Madera contra-Chapada - Шпон

L14
Noce - Walnut

L26
Rovere moro - Dark Oak

Alluminio - Aluminium - Aluminium - Aluminio - Alumionio - Алюминий

Y
Bianco - White

S
Corda - Corda

G
Grafite - Grafite

T
Testa di moro - Dark Brown

K
Satinato - Satin

Impiallacciato - Veneered wood - Bois plaqué - Holz furniert - Madera contra-Chapada - Шпон

L14
Noce - Walnut

L26
Rovere moro - Dark Oak

Melaminico - Melamine - Méla miné - Melamin - Melamina - Меламин

M01
Bianco - White

M07
Corda - Corda

M02
Grafite - Grafite

M12
Rok - Rok

M14
Noce - Walnut

MDF laccato - MDF laquered - MDF laqué - MDF lackiert - MDF lacado - Лакированный МДФ

D05
Bianco - White

D07
Corda - Corda

D02
Grafite - Grafite

D41
Testa di moro - Dark Brown

Cristallo - Glass - Verre - Glas - Verre - Стекло

VE5
Bianco lucido extra chiaro - Extra clear glossy white

V07
Corda lucido - Glossy sand

V02
Grafite lucido - Glosy grafite

Cristallo antigraffio - Antiscratch glass - Anti-rayures Verre - Kratzfestig Glas - Verre antirayaduras

VA5
Bianco satinato extrachiaro antigraffio - Extra clear matt white antiscratch

VA7
Corda satinato antigraffio - Matt sand antiscratch

VA2
Grafite satinato antigraffio - Matt grafite antiscratch

VAB
Testa di moro satinato antigraffio - Matt dark brown antiscratch

Cristalceramica - Crystalceramic - Cristal ceramic - Cristal Keramik - Cristal de Ceramica - Стеклокерамика

VC3
Oxide bianco - White oxide

VC4
Piombo - Lead

VC2
Basalto - Basalt

Impiallacciato - Veneered wood - Bois plaqué - Holz furniert - Madera contra-Chapada - Шпон

L14
Noce - Walnut

L26
Rovere moro - Dark Oak

MDF laccato - MDF laquered - MDF laqué - MDF lackiert - MDF lacado - Лакированный МДФ

D05
Bianco - White

D07
Corda - Corda

D02
Grafite - Grafite

D41
Testa di moro - Dark Brown

D02
Grafite - Grafite

D41
Testa di moro - Dark Brown

D02
Grafite - Grafite

D41
Testa di moro - Dark Brown

D02
Grafite - Grafite

D41
Testa di moro - Dark Brown

D02
Grafite - Grafite

D41
Testa di moro - Dark Brown

D02
Grafite - Grafite

D41
Testa di moro - Dark Brown

D02
Grafite - Grafite

D41
Testa di moro - Dark Brown

D02
Grafite - Grafite

D41
Testa di moro - Dark Brown

Portofino

design Cappellini & Licheri



PORTOFINO Tavolo fisso acciaio C, cristallo V3E - Fix table steel C, glass V3E

PORTOFINO Sedia acciaio C, ecopelle 722 - Chair steel C, ecoleather V3E



PORTOFINO Tavolo fisso acciaio C, cristallo V3E - Fix table steel C, glass V3E

PORTOFINO Sedia acciaio C, ecopelle 722 - Chair steel C, ecoleather V3E

PORTOFINO Tavolo fisso acciaio Z, legno corteccia LM1 - Fix table steel Z, wood bark LM1

CIAK Poltrona acciaio Z, cuoio U02 e U01 - Armchair steel Z, leather U02 and U01



Portofino fisso

Tavolo fisso con struttura in acciaio. Piani in: cristallo, impiallacciato o noce massello corteccia spessore 4 cm. - Fix table with steel base. Tops in: glossy glass, veneer or massive walnut wood 4cm. thickness. - Table fixe avec structure en acier. Plateaux en : verre brillant, plaqués ou noyer massif écorce épaisseur 4 cm

- Tisch mit Stahlgestell. Platte aus glänzendem Glass, furniertem Holz oder Nussbaum Massivholz von 4cm. - Mesa fija con estructura en acero. Sobre en cristal brillante, madera contra-chapada o madera maciza de nogal espesor 4 cm - Стол нераскладной на стальном основании. Столешницы из: глянцевого стекла, шпона или массива ореха толщиной 4см.

Dimensioni

Dimensions - Dimensions - Abmessung - Dimensiones - Размеры

cm L190xP106xH75
inch L74,8xW41,7xH29,5



posti | seats 8

cm L200xP106xH75
inch L78,7xW41,7xH29,5



posti | seats 8

cm L250xP106xH75
inch L98,4xW41,7xH29,5



posti | seats 10

Struttura

Frame - Structure - Gestell - Estructura - Структура

Piano

Top - Plateau - Platte - Sobre - Столешница

Acciaio - Steel - Acier - Stahl - Acero - Сталь

- Y** Bianco - White
- S** Corda - Corda
- G** Grafite - Grafite
- C** Cromo - Chrome
- Z** Nichel nero - Black nickel

Legno - Wood - Bois - Holz - Madera - Дерево

- LM1** Massello di noce corteccia - Solid walnut bark
- Impiallacciato** - Veneered wood - Bois plaqué - Holz furniert - Madera contra-Chapada - Шпон
- L14** Noce - Walnut
- L26** Rovere moro - Dark Oak
- Cristallo** - Glass - Verre - Glas - Verre - Стекло
- V3E** Trasparente extra chiaro - Extra clear transparent

* Disponibile solo per versione 190x106 e 250x106 - Available only 190x106 and 250x106

* * Disponibile solo per versione 200x106 e 250x106 - Available only 200x106 and 250x106

Klass

design Midj R&D



KLASS Tavolo all. 140/185/230x90 acciaio S, cristallceramica VC4 - Ext. table 140/185/230x90 steel S, crystalceramic VC4
NAOMI Sedia acciaio S, ecopelle 735 - Chair steel S, ecolleather 735



KLASS Tavolo all. 140/185/230x90 acciaio S, cristalceramica VC4 - Ext. table 140/185/230x90 steel S, crystalceramic VC4
NAOMI Sedia acciaio S, ecopelle 735 - Chair steel S, ecoleather 735

KLASS Tavolo all. 140/200x90 acciaio Y, cristallo antigraffio VA5 - Ext. table 140/200x90 steel Y, antiscratch glass VA5

PASSEPARTOUT Sedia acciaio Y cuoio rigenerato Z22 - Chair steel Y, regenerated leather Z22



CRISTALCERAMICA Il cristallo che resiste al calore
CRYSTALCERAMIC The crystal that resists to heat



Klass

Tavolo allungabile con struttura in acciaio e piani in: melaminico, MDF laccato, cristallo, cristallo antigraffio o cristalloceramica. - Extendable table with metal frame. Top in: melamin, laquered MDF, glass, antiscratch glass, Crystalceramic. - Table avec allonges et structure en acier. Plateau in: mélaminé, MDF laqué, verre, verreanti-rayures ou cristalceramic. - Ausziehbar Tisch mit Stahlgestell. Platte aus Melamin, lackiertes MDF, Glas oder kratzfestig Glas, Cristal Keramik.

Mesa extensible con estructura en acero. Sobre en melaminas, MDF lacado, cristal, cristal antirayaduras, cristal de ceramica. - Стол раскладной со стальным каркасом и столешницей из: меламина, лакированного дерева, стекла и устойчивого к царапинам стекла или стеклокерамики

Dimensioni

Dimensions - Dimensions - Abmessung - Dimensiones - Размеры

cm L120/170xP80xH75
 inch L47,2/66,9xW31,5xH29,5



posti | seats 6+2

cm L140/200xP90xH75
 inch L55,1/78,7xW35,4xH29,5



posti | seats 6+2

cm L140/185/230xP90xH75
 inch L55,1/72,8/90,5xW35,4xH29,5



posti | seats 6+2+2

Struttura

Frame - Structure - Gestell - Estructura - Структура

Piano e allonghe

top and extensions - plateau et allonges - platte und verlängerungen - sobre y prolongaciones - столешница и удлинители

Piano

Top - Plateau - Platte - Sobre - Столешница

Allunghe piani Cristallo

Extensions for glass top - Allonges pour plateau en verre - Verlängerungen Für Glas - Prolongaciones para sobre en verre - Удлинители столешниц из стекла

Acciaio - Steel - Acier - Stahl - Acero - Сталь

- Y** Bianco - White
- R** Alluminio - Aluminium
- S** Corda - Sand
- G** Grafite - Graphite
- T** Testa di moro - Dark Brown

Melaminico - Melamine - Mélaminé - Melamin - Melamina - Меламин

- M01** Bianco - White
- M07** Corda - Sand
- M02** Grafite - Graphite
- M12** Rok - Rok
- M14** Noce - Walnut

MDF laccato - MDF laquered - MDF laqué - MDF lackiert - MDF lacado - Лакированный МДФ

- D05** Bianco - White
- D07** Corda - Sand
- D02** Grafite - Graphite
- D41** Testa di moro - Dark Brown

Cristallo - Glass - Verre - Glas - Verre - Стекло

- VE5** Bianco lucido extra chiaro - Extra clear glossy white
- V07** Corda lucido - Glossy sand
- V02** Grafite lucido - Glosy graphite
- Cristallo antigraffio - Antiscratch glass - Anti-rayures Verre - Kratzfestig Glas - Verre antirayaduras**
- VA5** Bianco satinato extrachiaro antigraffio - Extra clear matt white antiscratch
- VA7** Corda satinato antigraffio - Matt sand antiscratch
- VA2** Grafite satinato antigraffio - Matt graphite antiscratch
- VAB** Testa di moro satinato antigraffio - Matt dark brown antiscratch

Cristalceramica - Crystalceramic - Cristal ceramique - Cristal Keramik - Cristal de Ceramica - Стеклокерамика

- VC3** Oxide bianco - White oxide
- VC4** Piombo - Lead
- VC2** Basalto - Basalt

MDF laccato - MDF laquered - MDF laqué - MDF lackiert - MDF lacado - Лакированный МДФ

- D05** Bianco - White
- D07** Corda - Sand
- D02** Grafite - Graphite
- D41** Testa di moro - Dark Brown

Badù L-XL

design StudioKappa



BADÙ XL Tavolo all. 140/190/240/290x90 acciaio Y, cristalceramica VC3 - Ext. table 140/190/240/290x90 steel Y, crystalceramic VC3

SILVY CU S-BR Sedia rigenerato Z42 - Chair regenerated leather Z42

SILVY CU P-BR Sedia rigenerato Z42 - Chair regenerated leather Z42



BADÙ XL Tavolo all. 140/190/240/290x90 acciaio Y, cristalceramica VC3 - Ext. table 140/190/240/290x90 steel Y, crystalceramic VC3
SILVY CU S-BR Sedia rigenerato Z42 - Chair regenerated leather Z42
SILVY CU P-BR Sedia rigenerato Z42 - Chair regenerated leather Z42



BADÙ XL Tavolo all. 140/190/240/290x90 acciaio Y, cristalceramica VC3 - Ext. table 140/190/240/290x90 steel Y, crystalceramic VC3



BADÙ XL Tavolo all. 140/190/240/290x90 acciaio Y, cristalceramica VC3 - Ext. table 140/190/240/290x90 steel Y, crystalceramic VC3

SILVY CU S-BR Sedia rigenerato Z42 - Chair regenerated leather Z42

SILVY CU P-BR Sedia rigenerato Z42 - Chair regenerated leather Z42



BADÙ XL Tavolo all. 140/190/240/290x90 acciaio Y, cristallceramica VC3 - Ext. table 140/190/240/290x90 steel Y, crystalceramic VC3
NENÈ S Sedia polipropilene P07 - Chair polypropylene P07



BADÙ XL Tavolo all. 140/185/230x90 acciaio C, cristalceramica VC4 - Ext. table 140/185/230x90 steel C, cristalceramica VC4
SILVY TS S-A Sedia acciaio C, ecopelle 726 - Chair steel C, ecolather 726



Badù / Badù L / Badù XL

Tavolo allungabile con struttura in acciaio e piani in: melaminico, MDF laccato, cristallo, cristallo antigraffio o cristalceramica. - Extendable table with metal frame. Top in: melamin, laquered MDF, glass, antiscratch glass, Crystalceramic. - Table avec allonges et structure en acier. Plateau in: mélaminé, MDF laqué, verre, verreanti-rayures ou cristalceramic. - Ausziehbar Tisch mit Stahlgestell. Platte aus Melamin, lackiertes MDF,

Glas oder kratzfestig Glas, Cristal Keramik. - Mesa extensible con estructura en acero. Sobre en melaminas, MDF lacado, cristal, cristal antirayaduras, cristal de ceramica. - Стол раскладной со стальным каркасом и столешницей из: меламина, лакированного дерева, стекла и устойчивого к царапинам стекла или стеклокерамики

Dimensioni

Dimensions - Dimensions - Abmessung - Dimensiones - Размеры

Badù
 cm L100/140xP70xH75
 inch L39,4/55,1xW27,6xH29,5



posti | seats 4+2

Badù
 cm L120/170xP80xH75
 inch L47,2/66,9xW31,5xH29,5



posti | seats 6+2

Badù
 cm L140/200xP90xH75
 inch L55,1/78,7xW35,4xH29,5



posti | seats 6+2

Badù L
 cm L140/185/225xP90xH75
 inch L55,1/72,8/88,6xW35,4xH29,5



posti | seats 6+2+2

Badù XL
 cm L110/155/200/245xP80xH75
 inch L43,3/61/78,7/96,5xW31,5xH29,5



posti | seats 4+2+2+2

Badù XL
 cm L140/190/240/290xP90xH75
 inch L55,1/74,8/94,5/114,2xW35,4xH29,5



posti | seats 6+2+2+2

Struttura

Frame - Structure - Gestell - Estructura - Структура

Piano e allunghe

top and extensions - plateau et allonges - platte und verlängerungen - sobre y prolongaciones - столешница и удлинители

Piano

Top - Plateau - Platte - Sobre - Столешница

Allunghe piani Cristallo e Cristalceramica

Extensions for glass and Crystalceramic top - Allonges pour plateau en verre et Cristal Ceramic - Verlängerungen Für Glas Und Cristal Keramikplatte - Prolongaciones para sobre en verre y Cristal De Ceramica - Удлинители столешниц из стекла и стеклокерамики

Acciaio

Steel - Acier - Stahl - Acero - Сталь

- Y** Bianco - White
- R** Alluminio - Aluminium
- S** Corda - Sand
- G** Grafite - Graphite
- T** Testa di moro - Dark Brown

Melaminico

Melamine - Melaminé - Melamin - Melamina - Меламин

- M01** Bianco - White
- M07** Corda - Sand
- M02** Grafite - Graphite
- M12** Rok - Rok
- M14** Noce - Walnut

MDF laccato

MDF laquered - MDF laqué - MDF lackiert - MDF lacado - Лакированный МДФ

- D05** Bianco - White
- D07** Corda - Sand
- D02** Grafite - Graphite
- D41** Testa di moro - Dark Brown

Cristallo

Glass - Verre - Glas - Verre - Стекло

- VE5** Bianco lucido extra chiaro - Extra clear glossy white
- V07** Corda lucido - Glossy sand
- V02** Grafite lucido - Glosy graphite

Cristallo antigraffio

Antiscratch glass - Anti-rayures Verre - Kratzfestig Glas - Verre antirayaduras

- VA5** Bianco satinato extrachiaro antigraffio - Extra clear matt white antiscratch
- VA7** Corda satinato antigraffio - Matt sand antiscratch
- VA2** Grafite satinato antigraffio - Matt graphite antiscratch
- VA8** Testa di moro satinato antigraffio - Matt dark brown antiscratch

Cristalceramica

Crystalceramic - Cristalceramic - Cristalceramique - Cristal Keramik - Cristal de Ceramica - Стеклокерамика

- VC3** Oxide bianco - White oxide
- VC4** Piombo - Lead
- VC2** Basalto - Basalt

MDF laccato

MDF laquered - MDF laqué - MDF lackiert - MDF lacado - Лакированный МДФ

- D05** Bianco - White
- D07** Corda - Sand
- D02** Grafite - Graphite
- D41** Testa di moro - Dark Brown

Guapa

design Sempere#Poli



INFINITY Tavolo fisso ø100 acciaio Y, cristallo VE5 - Fix table ø100 steel Y, glass VE5
GUAPA S Sedia acciaio Y, cuoio U22 e U66 - Chair steel Y, leather U22 and U66



GUAPA S Sedia acciaio C, cuoio U42 - Chair steel C, leather U42



GUAPA DN Sedia a dondolo acciaio C, cuoio U67 - Rocking chair, steel C, leather U67
GUAPA DN Sedia a dondolo acciaio Y, cuoio U66 - Rocking chair, steel Y, leather U66

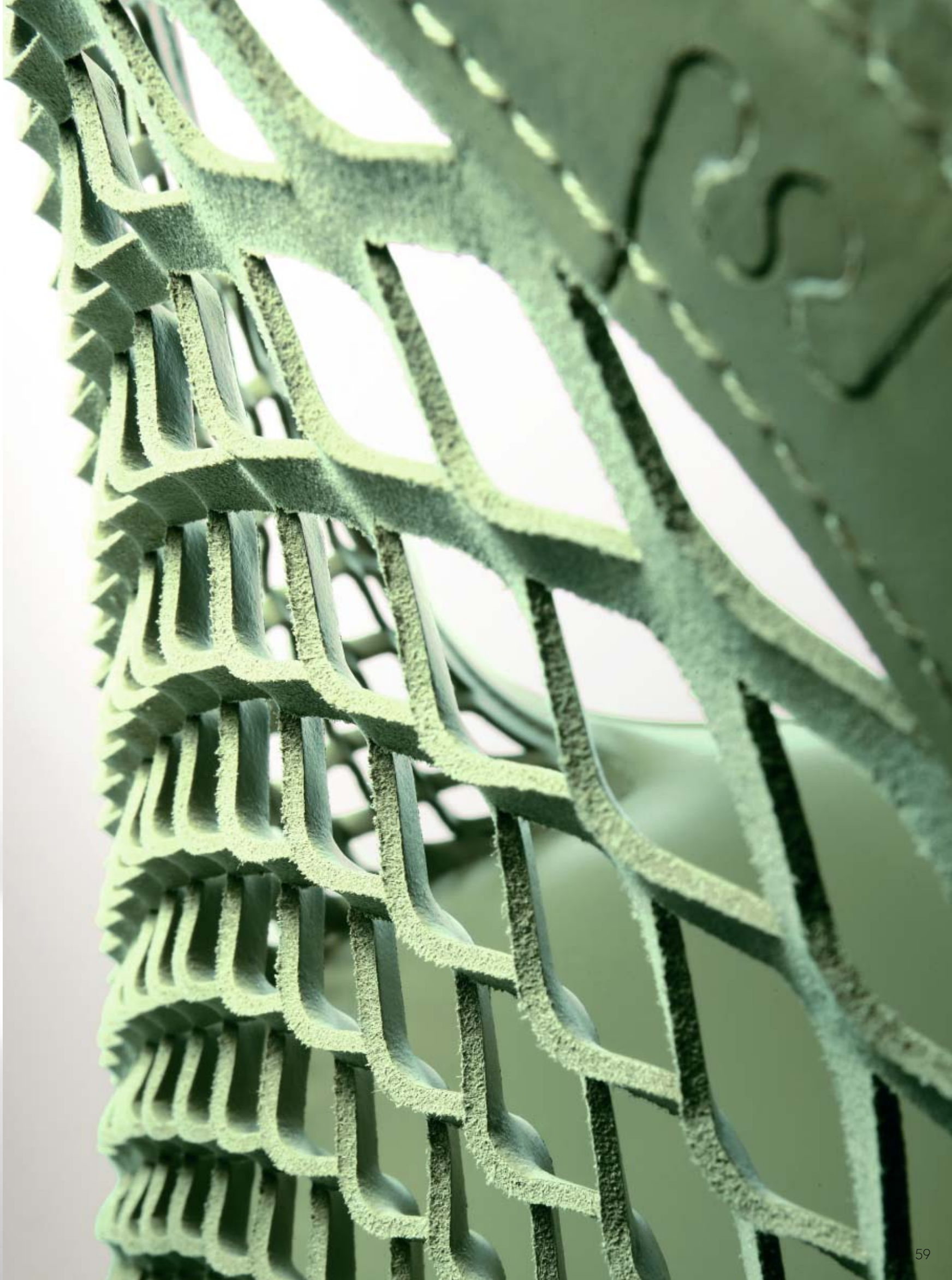



Guapa

Sedia, poltrona, sgabelli, dondolo, attesa e tavolini con struttura in acciaio cromato o laccato. Scocca in cuoio. - Chair, armchair, barstools, rocking chair, lounge chair and side tables with chromed or painted steel frame. Hide upholstery. - Chaise, fauteuil, tabourets, rocking-chair, attente et petite table avec structure en acier chromé ou laqué. Assise en cuir- Stuhl, Stuhl mit Armlehnen, Barhocker, Schaukel-, Warten Stuhl, Kaffeetische

mit Gestell aus verchromtem oder lackiertem Stahl. Gepolsterter mit Kernleder Sitz. - Silla, Sillón, taburetes, balancín, espera y mesitas con estructura en acero cromado o lacado. Carcasa en cuero. - Стул, кресло, барные стулья, качалка, кресло низкой посадки и кофейные столики с основанием из хромированной или окрашенной стали. Спинка и сиденье обиты.

Dimensioni

Dimensions - Dimensions - Abmessung - Dimensiones - Размеры

Guapa S cm L50xP52xH46/78 inch L19,7xW20,5xH18,1/30,7	Guapa P cm L67xP55xH46/82 inch L26,4xW21,6xH18,1/32,3	Guapa AT cm L81xP62xH41/82 inch L31,9xW24,4xH16,6/32,3	Guapa DN cm L67xP75xH46/81 inch L26,4xW29,5xH18,1/31,9	Guapa H65 cm L50xP54xH65/97 inch L19,7xW21,2xH25,6/38,2	Guapa H75 cm L50xP54xH75/107 inch L19,7xW21,2xH29,5/42,1
Guapa CT-S cm L42xP36xH52 inch L16,5xW14,2xH20,5	Guapa CT-M cm L63xP55xH42 inch L24,8xW21,6xH16,5	Guapa CT-L cm L125xP75xH32 inch L49,2xW29,5xH12,6			

Struttura

Frame - Structure - Gestell - Estructura - Структура

Seduta e schienale

Seat and back - Assise et dossier - Sitz Und Lehne - Asiento y respaldo - сидение и спинка

Acciaio - Steel - Acier - Stahl - Acero - Сталь

Cuoio - Hide - Cuir - Kernleder - Cuero - Натуральная Кожа

C
Cromo - Chrome

Vedi campionario per scegliere il colore - Check the swatches for colours - Voir l'échantillon pour choisir la couleur - Siehe Musterkarte um die Farbe zu wählen - Ver muestras para elegir el color - Смотреть образцы для выбора цвета

Z
Nichel nero - Black nickel

Y
Bianco - White

Apelle

design Beatriz Sempere



APELLE P Sedia acciaio C, cuoio U05 - Chair steel C, leather U05
APELLE S Sedia acciaio Z, cuoio U22 - Chair steel Z, leather U22



APELLE S Sedia acciaio Y, cuoio U05, U22 e U21 - Chair steel Y, leather U05, U22 and U21

APELLE H65 Sgabello acciaio Y, cuoio U05 - Stool steel Y, leather U05



APELLE AT Sedia acciaio C, cuoio U66 - Chair steel C, leather U66
APELLE POUF Pouf acciaio C, cuoio U66 - Pouf steel C, leather U66



APELLE DN Sedia acciaio Z, cuoio U64 - Chair steel Z, leather U64
APELLE CT Tavolino acciaio Z, cuoio U64 - Coffee table steel Z, leather U64



H65

H75

S

P



DN

AT LG

POUF

AT

Apelle

Sedia, poltrona, sgabelli, dondolo, attesa, pouf e tavolino con struttura in acciaio cromato o laccato. Scocca in cuoio. - Chair, armchair, barstools, rocking chair, lounge chair, pouf and side table with chromed or painted steel frame. Hide upholstery. - Chaise, fauteuil, tabourets, rocking-chair, attente, pouf et petite table avec structure en acier chromé ou laqué. Assise en cuir

- Stuhl, Stuhl mit Armlehnen, Barhocker, Schaukel-, Lounge Stuhl, Pouf, Kaffeetisch mit Gestell aus verchromtem oder lackiertem Stahl. Gepolsterter mit Kernleder Sitz. - Silla, Sillón, taburetes, balancín, espera, pouf y mesitas con estructura en acero cromado o lacado. Carcasa en cuero - Стул, кресло, барные стулья, качалка, кресло низкой посадки, пуф и кофейный столик с основанием из хромированной или окрашенной стали. Спинка и сиденье обиты.

Apelle AT LG

Attesa con struttura in acciaio cromato. Scocca in legno. - Lounge chair with chromed steel frame. Wooden seat. - Attente avec structure en acier chromé. Assise en bois - Lounge Stuhl mit verchromtem Gestell. Holz sitz.

- Espera con estructura en acero cromado. Carcasa en madera. - Кресло низкой посадки Lounge с основанием из хромированной стали. Спинка и сиденье из дерева.

Dimensioni

Dimensions - Dimensions - Abmessung - Dimensiones - Размеры

Apelle S

cm L51xP55xH46/80
inch L20,1xW21,6xH18,1/31,5

Apelle P

cm L59xP54xH46/80
inch L23,2xW21,5xH18,1/31,5

Apelle AT

cm L79xP73xH40/82
inch L31,1xW28,7xH15,7/32,3

Apelle DN

cm L80xP86xH40/80
inch L31,5xW33,8xH15,7/31,5

Apelle H65

cm L51xP51xH65/91
inch L20,1xW20,1xH25,6/35,8

Apelle H75

cm L51xP51xH75/101
inch L20,1xW20,1xH29,5/39,8

Apelle CT

cm L39xP37xH49
inch L15,3xW14,6xH19,3

Apelle Pouf

cm L68xP42xH45
inch L26,8xW16,5xH17,7

Struttura

Frame - Structure - Gestell - Estructura - Структура

Struttura

Frame - Structure - Gestell - Estructura - Структура

Seduta e schienale

Seat and back - Assise et dossier - Sitz Und Lehne - Asiento y respaldo - сидение и спинка

S, P, H65, H75, CT

Acciaio - Steel - Acier - Stahl - Acero - Сталь

C Cromo - Chrome

Z Nichel nero - Black nickel

R Oro rosa - Pink gold

Y Bianco - White

AT, DN, POUF

Acciaio - Steel - Acier - Stahl - Acero - Сталь

C Cromo - Chrome

Z Nichel nero - Black nickel

Y Bianco - White

Cuoio - Hide - Cuir - Kernleder - Cuero - Натуральная Кожа

Vedi campionario per scegliere il colore - Check the swatches for colours - Voir l'échantillon pour choisir la couleur - Siehe Musterkarte um die Farbe zu wählen - Ver muestras para elegir el color - Смотреть образцы для выбора цвета

Dimensioni

Dimensions - Dimensions - Abmessung - Dimensiones - Размеры

cm L79xP73xH40/82

inch L31,1xW28,7xH15,7/32,3

Struttura

Frame - Structure - Gestell - Estructura - Структура

Seduta e schienale

Seat and back - Assise et dossier - Sitz Und Lehne - Asiento y respaldo - сидение и спинка

Acciaio - Steel - Acier - Stahl - Acero - Сталь

Legni - Wood - Bois - Holz - Madera - Дерево

C Cromo - Chrome

Z Nichel nero - Black nickel

Y Bianco - White

L24 Impiallacciato noce fiammato - Veneered wood flamed walnut

Portofino

design Cappellini & Licheri



PORTOFINO Sedia acciaio C, ecopelle 722- Chair steel C, ecoleather 722



PORTOFINO Sedia acciaio C, ecopelle 735- Chair steel C, ecoleather 735



Portofino

Poltrona con struttura in acciaio cromato o laccato. Scocca rivestita.
- Armchair with chromed or painted steel frame. Upholstered seat.
- Fauteuil avec structure en acier chromé ou laqué. Assise revêtue

- Stuhl mit Armlehnen mit Gestell aus verchromtem oder lackiertem Stahl. Gepolsterter Sitz. - Sillón con estructura en acero cromado o lacado. Carcasa tapizada. - Кресло с основанием из хромированной или окрашенной стали. Спинка и сиденье обиты.

Dimensioni

Dimensions - Dimensions - Abmessung - Dimensiones - Размеры

Portofino
cm L67xP60xH45/80
inch L26,3xW23,6xH17,7/31,5

Struttura

Frame - Structure - Gestell -
Estructura - Структура

Scocca

Shell - Assise - Schale - Carcasa -
Сидение И Спинка

Acciaio - Steel - Acier - Stahl - Acero - Сталь

Y
Bianco - White

C
Cromo - Chrome

Pelle - Leather - Peau - Leder - Piel - Натуральная
кожа

Ecopelle - Ecoleather - Similcuir - Kunstleder -
Ecopiel - Искусственная Кожа

Tessuto - Fabric - Tissu - Stoff - Tejido - Ткань

Vedi campionario per scegliere il colore - Check
the swatches for colours - Voir l'échantillon pour
choisir la couleur - Siehe Musterkarte um die
Farbe zu wählen - Ver muestras para elegir el
color - Смотреть образцы для выбора цвета

Ciak

design Cappellini & Licheri



Ciak

Poltrona con struttura in acciaio cromato o nichel nero. Sedile, schienale e braccioli in cuoio. - Armchair with chromed steel or black nickel frame. Seat, back and armrests in hide. - Fauteuil avec structure en acier chromé ou nickel noir. Assise, dossier et accoudoirs en cuir

- Stuhl mit Armlehnen mit Gestell aus verchromtem Stahl oder Schwarzem Nickel. Sitz, Rücken und Armlehnen mit Kernleder bezogen. - Sillón con estructura en acero cromato o níquel negro. Asiento, Respaldo y brazos en cuero. - Кресло с основанием из хромированной стали или черного никеля. Спинка, сиденье и подлокотники выполнены из полутвердой кожи (cuoio).

Dimensioni

Dimensions - Dimensions - Abmessung - Dimensiones - Размеры

Ciak
cm L59xP46xH47/82
inch L23,2xW18,1xH18,5/32,3

Struttura

Frame - Structure - Gestell - Estructura - Структура

Seduta e schienale

Seat and back - Assise et dossier - Sitz Und Lehne - Asiento y respaldo - сидение и спинка

Acciaio - Steel - Acier - Stahl - Acero - Сталь

C
Cromo - Chrome

Z
Nichel nero - Black nickel

Cuoio - Hide - Cuir - Kernleder - Cuero -
Натуральная Кожа

Vedi campionario per scegliere il colore
- Check the swatches for colours - Voir
l'échantillon pour choisir la couleur - Siehe
Musterkarte um die Farbe zu wählen - Ver
muestras para elegir el color - Смотреть
образцы для выбора цвета

Sonny

design R&D



SONNY P-MT Sedia acciaio C, tessuto natural wool 473 / ecopelle vintage 7V8
- Chair steel C, fabric natural wool 473/ecoleather vintage 7V8



SONNY P-LG Sedia legno L14, tessuto natural wool 473 / ecopelle vintage 7V8
- Chair steel L14, fabric natural wool 473/ecoleather vintage 7V8

Sonny

Sedia, poltrona con struttura in legno, acciaio cromato o laccato. Scocca rivestita. - Chair, armchair with structure wood, chrome or laquered steel. Upholstered shell. - Chaise, fauteuil en bois, acier chromé ou laqué. Assise revêtue.

- Stuhl, Armstuhl mit Gestell aus Stahl verchromt oder lackiert, Holz. Schale komplett bezogen. - Silla, sillón con estructura en madera, acero cromado o lacado. Carcasa tapizada. - Стул, кресло с основанием из дерева, хромированной или окрашенной стали. Спинка и сиденье обиты.

Dimensioni

Dimensions - Dimensions - Abmessung - Dimensiones - Размеры

Sonny S-LG, S-MT
cm L52xP58xH46/82
inch L20,5xW22,8xH18,1/32,3

Sonny P-LG, P-MT
cm L58xP58xH46/82
inch L22,8xW22,8xH18,1/32,3

Struttura

Frame - Structure - Gestell - Estructura - Структура

S-LG, P-LG

Legno - Wood - Bois - Holz - Madera - Дерево

Y
Bianco - White

L14
Noce - Walnut

L26
Rovere moro - Dark Oak

L40
Rovere naturale - Natural Oak

Struttura

Frame - Structure - Gestell - Estructura - Структура

S-MT, P-MT

Acciaio - Steel - Acier - Stahl - Acero - Сталь

Y
Bianco - White

C
Cromo - Chrome

Scocca

Shell - Assise - Schale - Carcasa - Сидение И Спинка

Pelle - Leather - Peau - Leder - Piel - Натуральная кожа

Ecopelle - Ecoleather - Similcuir - Kunstleder - Ecorpiel - Искусственная Кожа

Tessuto - Fabric - Tissu - Stoff - Tejido - Ткань

Vedi campionario per scegliere il colore - Check the swatches for colours - Voir l'échantillon pour choisir la couleur - Siehe Musterkarte um die Farbe zu wählen - Ver muestras para elegir el color - Смотреть образцы для выбора цвета

SONNY S-LG Sedia legno L14, tessuto natural wool 473 - Chair wood L14, fabric natural wool 473

Marilyn

design Midj R&D



MARILYN P-LG Sedia legno L26, tessuto natural wool 473/458 - Chair wood L26, fabric natural wool 473/458



MARILYN P-MT Sedia acciaio Y, tessuto natural wool 456 - Chair steel Y, fabric natural wool 456
MARILYN P-C Sedia acciaio Y, tessuto long life 369/ecopelle trapuntata 722 - Chair steel Y, fabric long life 369/ back quilted ecoleather 710



MARILYN S-LG Sedia legno L14, ecopelle 736/ecopelle trapuntata 722 - Chair wood L14, ecoleather 736/ back quilted ecoleather 710



MARILYN S-C Sedia acciaio Y, long life 376- Chair steel Y, long life 376



MARILYN S-MT Sedia acciaio S, natural wool 473/458- Chair steel S, natural wool 473/458

Marilyn

Sedia, poltrona con struttura in legno, acciaio cromato o laccato. Scocca rivestita. - Chair, armchair with structure wood, chrome or laquered steel. Upholstered shell. - Chaise, fauteuil en bois, acier chromé ou laqué. Assise revêtue.

- Stuhl, Armstuhl mit Gestell aus Stahl verchromt oder lackiert, Holz. Schale komplett bezogen. - Silla, sillón con estructura en madera, acero cromado o lacado. Carcasa tapizada. - Стул, кресло с основанием из дерева, хромированной или окрашенной стали. Спинка и сиденье обиты.

Dimensioni

Dimensions - Dimensions - Abmessung - Dimensiones - Размеры

Marilyn S-LG, S-C, S-MT
cm L49xP54xH48/81
inch L19,3xW21,2xH18,9/31,9

Marilyn P-LG, P-C, P-MT
cm L53xP54xH48/65/81
inch L20,9xW21,2xH18,9/25,6/31,9

Struttura

Frame - Structure - Gestell - Estructura - Структура

S-LG, P-LG

Legno - Wood - Bois - Holz - Madera - Дерево

Y
Bianco - White

L14
Noce - Walnut

L26
Rovere moro - Dark Oak

L40
Rovere naturale - Natural Oak

Struttura

Frame - Structure - Gestell - Estructura - Структура

S-C, P-C

Acciaio - Steel - Acier - Stahl - Acero - Сталь

Y
Bianco - White

C
Cromo - Chrome

Struttura

Frame - Structure - Gestell - Estructura - Структура

S-MT, P-MT

Acciaio - Steel - Acier - Stahl - Acero - Сталь

Y
Bianco - White

S
Corda - Corda

D
Grigio cenere - Ash gray

Scocca

Shell - Assise - Schale - Carcasa - Сидение И Спинка

Pelle - Leather - Peau - Leder - Piel - Натуральная кожа

Ecopelle - Ecoleather - Similcuir - Kunstleder - Ecopiel - Искусственная Кожа

Tessuto - Fabric - Tissu - Stoff - Tejido - Ткань

Vedi campionario per scegliere il colore - Check the swatches for colours - Voir l'échantillon pour choisir la couleur - Siehe Musterkarte um die Farbe zu wählen - Ver muestras para elegir el color - Смотреть образцы для выбора цвета

Naomi

design Midi R&D



NAOMI TS Sedia acciaio S, ecopelle 735 - Chair steel S, ecoleather 735



NAOMI TS Sedia acciaio Y, ecopelle 722 - Chair steel Y, ecoleather 722



NAOMI CU Sedia acciaio C, cuoio U53 - Chair steel C, leather U53

Naomi

Sedia con struttura in acciaio cromato o laccato. Seduta e schienale rivestiti. - Chair with steel structure, chrome or laquered. Seat and back upholstered. - Chaise avec structure en acier chromé ou laqué. Assise et dossier revêtus.

- Stuhl mit Gestell aus Stahl, verchromt oder lackiert. Sitz und Lehne komplett bezogen. - Silla con estructura en acero cromado o lacado. Asiento y respaldo tapizados. - Стул со стальным каркасом: хром или лак. Спинка и сидение обиты.

Dimensioni

Dimensions - Dimensions - Abmessung - Dimensiones - Размеры

cm L45xP57xH45/98
inch L17,7xW18,9xH17,7/38,6

Struttura

Frame - Structure - Gestell - Estructura - Структура

Acciaio - Steel - Acier - Stahl - Acero - Сталь

Y
Bianco - White

R
Alluminio - Aluminium

S
Corda - Corda

C
Cromo - Chrome

Seduta e schienale

Seat and back - Assise et dossier - Sitz Und Lehne - Asiento y respaldo - сидение и спинка

Pelle - Leather - Peau - Leder - Piel - Натуральная кожа

Ecopelle - Ecoleather - Similcuir - Kunstleder - Escopiel - Искусственная Кожа

Tessuto - Fabric - Tissu - Stoff - Tejido - Ткань

Cuoio - Hide - Cuir - Kernleder - Cuero - Натуральная Кожа

Cuoio rigenerato - Rigenenerated hide - Synderme - Rigeniertes leder - Cuero regenerado - Регенерированная Кожа

Vedi campionario per scegliere il colore - Check the swatches for colours - Voir l'échantillon pour choisir la couleur - Siehe Musterkarte um die Farbe zu wählen - Ver muestras para elegir el color - Смотреть образцы для выбора цвета

Silvy CU

design Midj R&D



SILVY CU S-BR Sedia cuoio U42 - Chair leather U42



SILVY CU S-AR Sedia cuoio U18 - Chair leather U18



SILVY CU P-B Sedia acciaio C, cuoio U42 - Chair steel C, leather U42

SILVY CU P-BR Sedia cuoio U42 - Chair leather U42



Silvy CU

Sedia con struttura in acciaio cromato, laccato o completamente rivestita. - Chair with steel structure, chrome, laquered or fully upholstered. - Chaise avec structure en acier chromé, laqué ou complètement revêtue.

- Stuhl mit Gestell aus Stahl, verchromt, lackiert oder komplett bezogen. - Silla con estructura en acero cromado, lacado o completamente tapizada. - Стул со стальным каркасом, хром, лак или полностью обитый.

Dimensioni

Dimensions - Dimensions - Abmessung - Dimensiones - Размеры

Silvy CU S-B, S-BR
cm L43xP52xH46/88
inch L16,9xW20,5xH18,1/34,6

Silvy CU S-A, S-AR
cm L43xP55xH46/98
inch L16,9xW21,7xH18,1/38,6

Silvy CU P-B, P-BR
cm L57xP52xH46/88
inch L18,9xW20,5xH18,1/34,6

Silvy CU H65
cm L45xP48xH65/94
inch L17,7xW18,9xH25,6/37

Silvy CU H75
cm L45xP48xH75/104
inch L17,7xW18,9xH29,5/40,9

Struttura

Frame - Structure - Gestell - Estructura - Структура

S-B, S-A, P-B, H65, H75

Acciaio - Steel - Acier - Stahl - Acero - Сталь

Y
Bianco - White

R
Alluminio - Aluminium

C
Cromo - Chrome

Seduta e schienale

Seat and back - Assise et dossier - Sitz Und Lehne - Asiento y respaldo - сидение и спинка

S-B, S-A, P-B, H65, H75

Cuoio - Hide - Cuir - Kernleder - Cuero - Натуральная Кожа

Cuoio rigenerato - Regenerated hide - Synderme - Regeneriertes leder - Cuero regenerado - Регенерированная Кожа

Vedi campionario per scegliere il colore - Check the swatches for colours - Voir l'échantillon pour choisir la couleur - Siehe Musterkarte um die Farbe zu wählen - Ver muestras para elegir el color - Смотреть образцы для выбора цвета

Struttura, seduta e schienale

Structure, seat and back - Structure, assise et dossier - Gestell, Sitz Und Lehne - Каркас, Сидение И Спинка

S-BR, S-AR

Cuoio - Hide - Cuir - Kernleder - Cuero - Натуральная Кожа

Cuoio rigenerato - Regenerated hide - Synderme - Regeneriertes leder - Cuero regenerado - Регенерированная Кожа

Vedi campionario per scegliere il colore - Check the swatches for colours - Voir l'échantillon pour choisir la couleur - Siehe Musterkarte um die Farbe zu wählen - Ver muestras para elegir el color - Смотреть образцы для выбора цвета

Silvy TS

design Midj R&D



S-BR

S-AR

S-A

H65

H75

Silvy TS

Sedia con struttura in acciaio cromato, laccato o completamente rivestita. - Chair with steel structure, chrome, laquered or fully upholstered. - Chaise avec structure en acier chromé, laqué ou complètement revêtue.

- Stuhl mit Gestell aus Stahl, verchromt, lackiert oder komplett bezogen. - Silla con estructura en acero cromado, lacado o completamente tapizada. - Стул со стальным каркасом, хром, лак или полностью обитый.

Dimensioni

Dimensions - Dimensions - Abmessung - Dimensiones - Размеры

Silvy TS S-B, S-BR
cm L43xP52xH46/88
inch L16,9xW20,5xH18,1/34,6

Silvy TS S-A, S-AR
cm L43xP55xH46/98
inch L16,9xW21,7xH18,1/38,6

Silvy TS P-B, P-BR
cm L57xP52xH46/88
inch L18,9xW20,5xH18,1/34,6

Silvy TS H65
cm L45xP48xH65/94
inch L17,7xW18,9xH25,6/37

Silvy TS H75
cm L45xP48xH75/104
inch L17,7xW18,9xH29,5/40,9

Struttura

Frame - Structure - Gestell - Estructura - Структура

S-B, S-A, P-B, H65, H75

Acciaio - Steel - Acier - Stahl - Acero - Сталь

Y
Bianco - White

R
Alluminio - Aluminium

C
Cromo - Chrome

Seduta e schienale

Seat and back - Assise et dossier - Sitz Und Lehne - Asiento y respaldo - сидение и спинка

S-B, S-A, P-B, H65, H75

Pelle - Leather - Peau - Leder - Piel - Натуральная кожа

Ecopelle - Ecoleather - Similcuir - Kunstleder - Ecorpiel - Искусственная Кожа

Tessuto - Fabric - Tissu - Stoff - Tejido - Ткань

Vedi campionario per scegliere il colore - Check the swatches for colours - Voir l'échantillon pour choisir la couleur - Siehe Musterkarte um die Farbe zu wählen - Ver muestras para elegir el color - Смотреть образцы для выбора цвета

Struttura, seduta e schienale

Structure, seat and back - Structure, assise et dossier - Gestell, Sitz Und Lehne - Каркас, Сидение И Спинка

S-BR, S-AR

Pelle - Leather - Peau - Leder - Piel - Натуральная кожа

Ecopelle - Ecoleather - Similcuir - Kunstleder - Ecorpiel - Искусственная Кожа

Tessuto - Fabric - Tissu - Stoff - Tejido - Ткань

Vedi campionario per scegliere il colore - Check the swatches for colours - Voir l'échantillon pour choisir la couleur - Siehe Musterkarte um die Farbe zu wählen - Ver muestras para elegir el color - Смотреть образцы для выбора цвета



Espositore

Espositore per sedie con struttura modulare in acciaio laccato bianco. Ripiani superiori in vetro trasparente. Ripiani inferiori in vetro acidato. - Chairs display with modular structure in white painted steel. Upper shelves in transparent glass. Lower shelves in frosted glass. - Exposer pour chaises avec une structure modulaire en acier laqué blanc. Étagères supérieures en verre transparent. Étagères inférieures en verre dépoli. - Stuhlregal mit

Modulgestell aus weiß lackiertem Stahl. Obere Regale aus transparentem Glass. Untere Regale aus geätzttem Glass. - Expositor para sillas con estructura modular en acero lacado blanco. Estantes superiores en cristal transparente. Estantes inferiores en vidrio esmerilado. - Экспозитор для стульев с модульной структурой из окрашенной в белый цвет стали. Верхние полки – из прозрачного стекла. Нижние полки – из окисленного стекла.



Modulo

Dimensioni

Dimensions - Dimensions - Abmessung - Dimensiones - Размеры

cm L74xP74xH200
inch L29,1xW29,1xH78,7

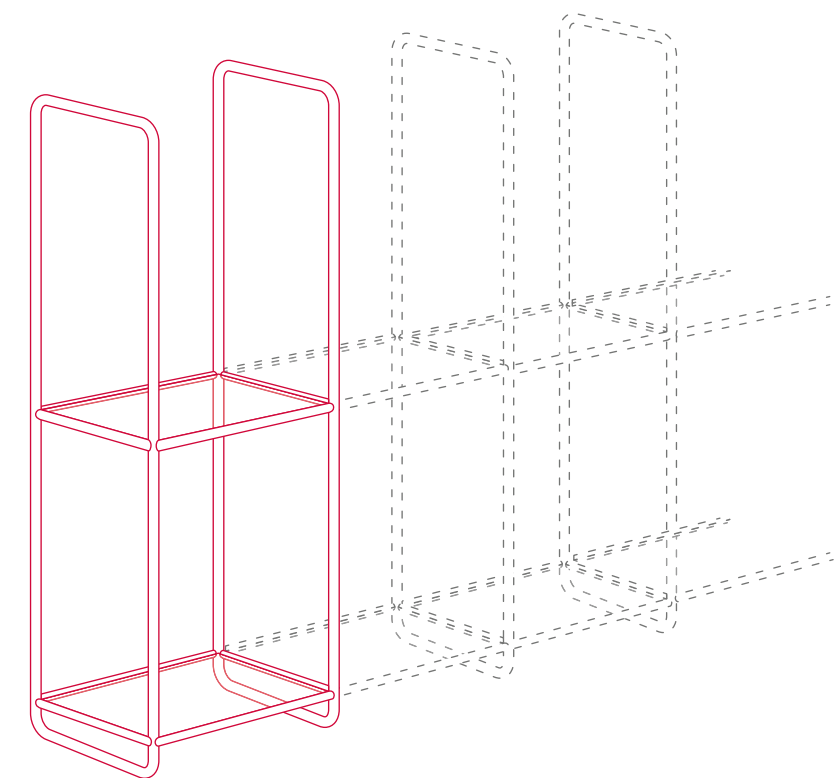
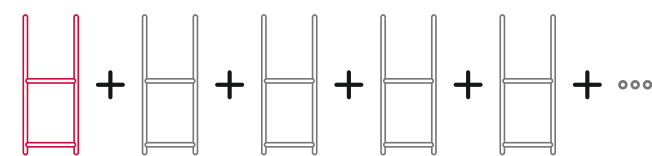

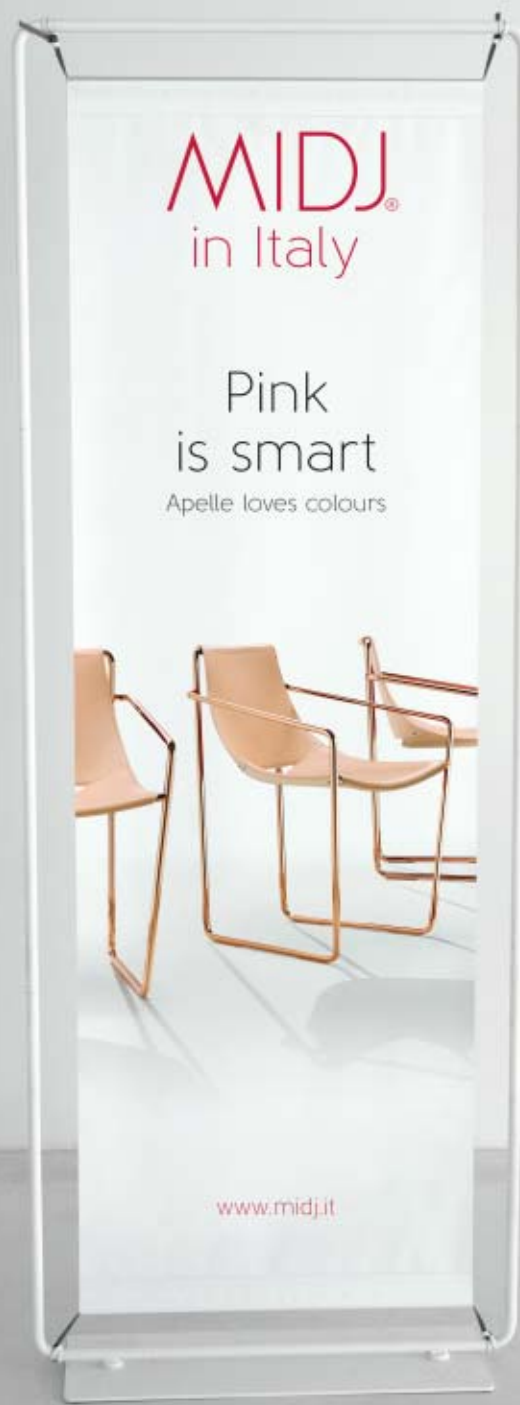

Banner

Dimensioni

Dimensions - Dimensions - Abmessung - Dimensiones - Размеры

cm L74xP25xH200
inch L29,1xW9,8xH78,7



Cristalceramica - Crystalceramic



VC3
Oxide bianco
White oxide



VC2
Basalto
Basalt



VC4
Piombo
Lead

I piani in cristalceramica provengono dalla tecnologia costruttiva del gres ceramico.

Realizzati con impianti ed attrezzature molto avanzate, uniscono allo spessore ridotto, un'elevata resistenza alle sollecitazioni meccaniche, ai prodotti chimici, all'usura, ai graffi, all'abrasione e resistono al gelo ed al fuoco.

Il processo di cottura a 1200 gradi di vari impasti di argilla, sabbia, silice ed altre sostanze naturali ne garantiscono l'assoluta originalità e massima riciclaggio ambientale.

Leggerissime imperfezioni di superficie e di lievi differenze cromatiche sono da considerare elementi naturali che ne accertano l'originalità e l'autenticità del prodotto.

The tops in cristalceramic come from construction technology of ceramic stoneware.

Made with highly advanced facilities and equipment, combine to the reduced thickness, high resistance to mechanical stresses, chemical products, wear, scratches, abrasion and they are resistant to frost and fire.

The cooking process at 1200 degrees of various mixtures of clay, sand, silica and other natural substances guarantees the absolute originality and maximum environmental recycling.

Slight surface imperfections and slight color differences are considered natural elements which ensure the originality and authenticity of the product.

Cristalli - Glasstop



VE5
Bianco lucido
extra chiaro
Extra clear
glossy white



VA5
Bianco extrachiaro
satinato antigraffio
Extra clear matt
white antiscratch



V07
Corda lucido
Glossy sand

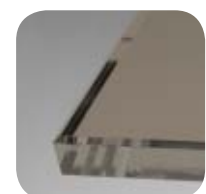

VA7
Corda satinato
antigraffio
Matt sand
antiscratch



V02
Grafite lucido
Glossy grafite



VA2
Grafite satinato
antigraffio
Matt grafite
antiscratch

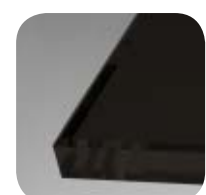

VA8
Testa di moro
satinato antigraffio
Matt dark brown
antiscratch



V3E
Trasparente
extra chiaro
Extra clear
transparent



V30
Trasparente
Transparent

Tessuto long life - Long life fabric

Cat. C



367
Blu
Blue



372
Vinaccia
Vinaccia



368
Rosso scuro
Dark red



365
Arancio
Orange



369
Giallo
Yellow



366
Marrone
Brown



37A
Verde mela
Apple green



37B
Verde oliva
Olive green



378
Corteccia
Corteccia



376
Cemento
Cemento



375
Sabbia
Sand



371
Beige
Beige



370
Antracite
Anthracite

Tessuto natural wool - Natural wool fabric Cat. A

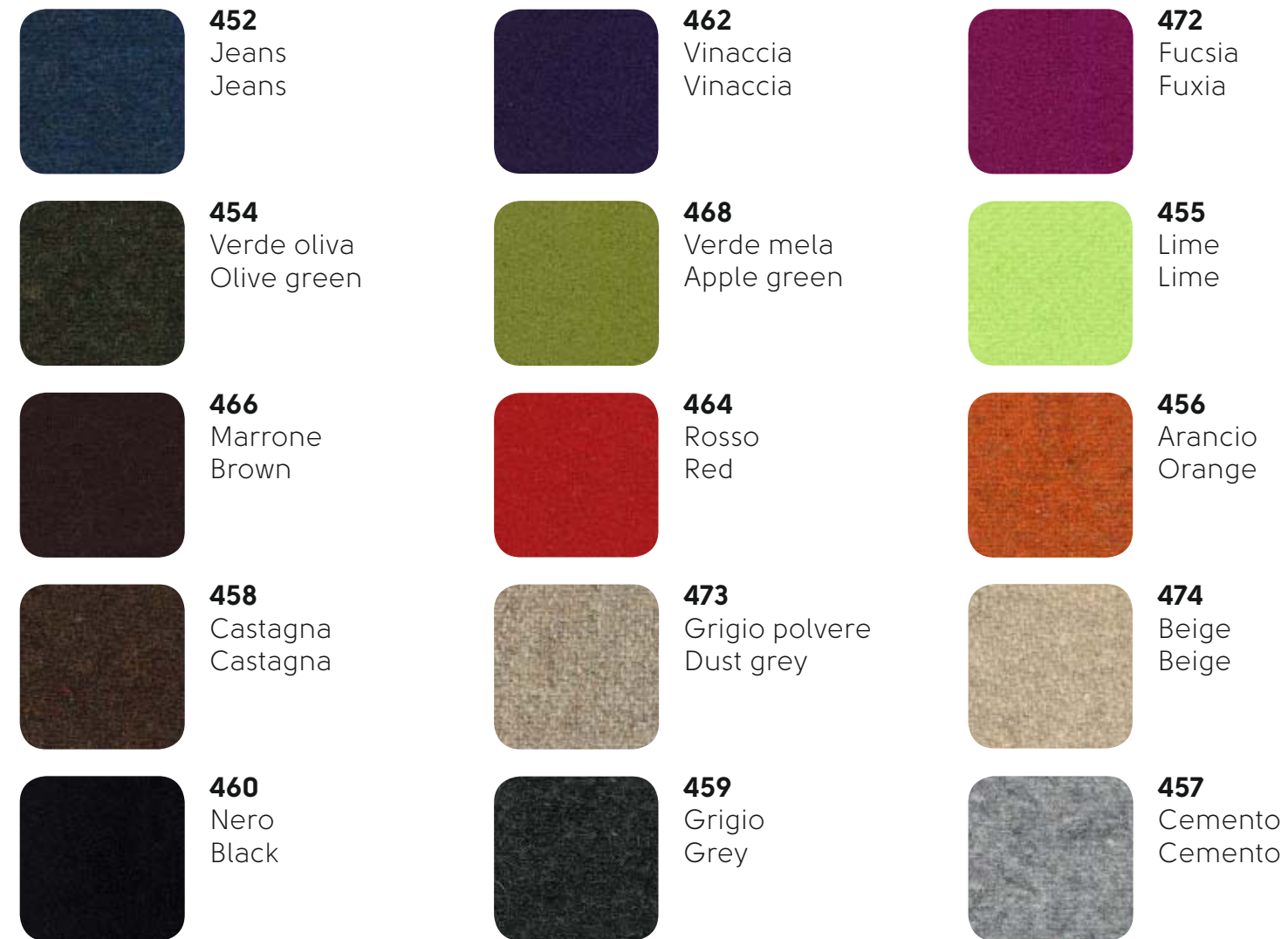

Tessuto mirage - Mirage fabric

Cat. C



Tessuto Pix - Pix fabric



29G
Azzurro
Light blue

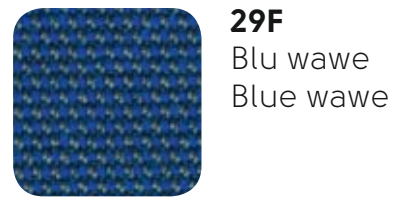

29F
Blu wawe
Blue wawe

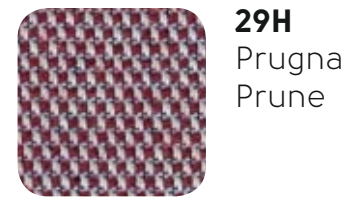

29H
Prugna
Prune



29K
Giallo
Yellow

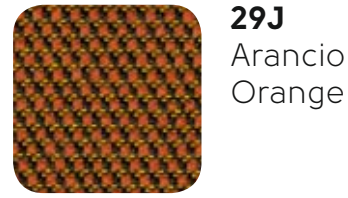

29J
Arancio
Orange



29I
Rosso porpora
Purple red



29M
Verde mela
Apple green



29L
Verde muschio
Muschio green



29A
Pepe
Pepper

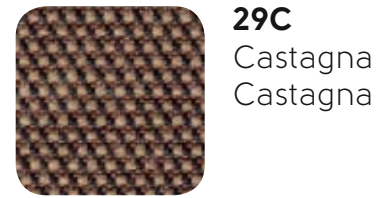

29C
Castagna
Castagna



29E
Sabbia
Sand

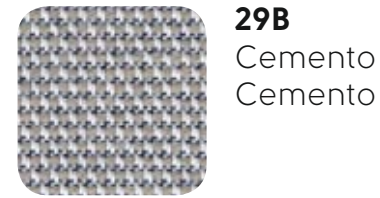

29B
Cemento
Cemento



29D
Corteccia
Corteccia

Ecopelle Magic - Magic Ecoleather

Cat. C



726
Avio
Avio

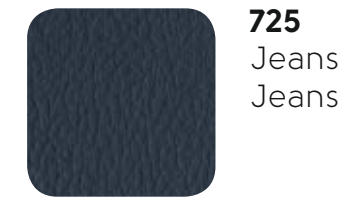

725
Jeans
Jeans

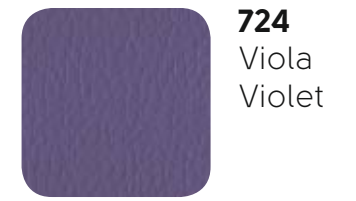

724
Viola
Violet

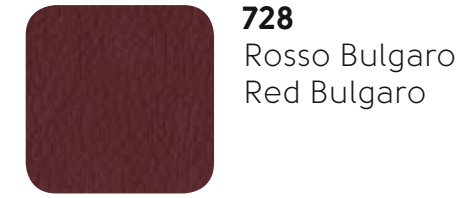

728
Rosso Bulgaro
Red Bulgaro



733
Rosso
Red

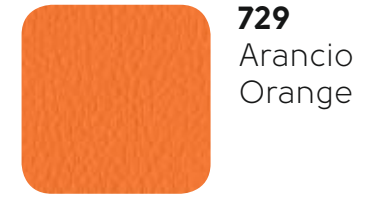

729
Arancio
Orange



734
Oca
Ocher



737
Lime
Lime



722
Bianco
White

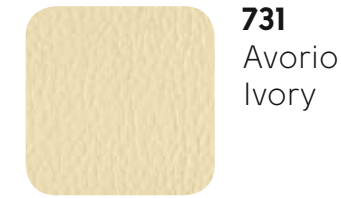

731
Avorio
Ivory

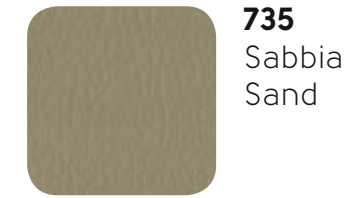

735
Sabbia
Sand

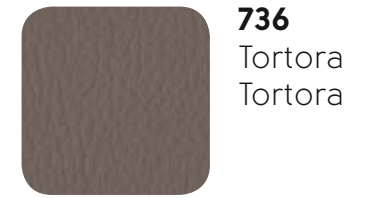

736
Tortora
Tortora



738
Grigio cenere
Ash grey



718
Grigio Polvere
Dust Grey

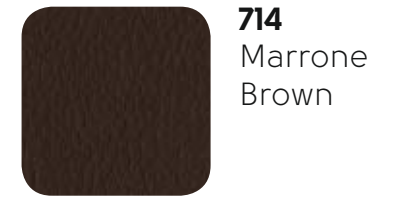

714
Marrone
Brown



742
Grafite
Grafite

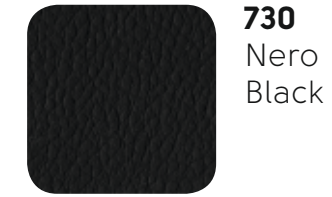

730
Nero
Black

Ecopelle Inca - Inca ecoleather



Pelle vintage - Vintage leather



Ecopelle vintage - Vintage ecoleather cat. A



Pelle special - Special leather



E42
Rosso
Red



E22
Ocra
Ocher



E34
Vaniglia
Vanilla



E05
Bianco
White



E18
Grigio cenere
Ash gray



E03
Grigio polvere
Dust grey



E41
Testa di moro
Dark brown



E04
Nero
Black

Pelle fiore - Fiore leather



F05
Bianco
White



F09
Sky
Sky

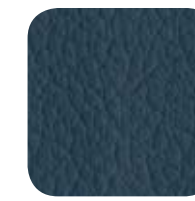

F38
Denim
Denim



F01
Bordeaux
Bordeaux



F42
Rosso
Red



F51
Verde oliva
Olive green



F22
Ocra
Ocher



F34
Vaniglia
Vanilla



F20
Fumo
Smoke



F41
Testa di moro
Dark brown



F25
Caffè
Coffee



F54
Fango
Fango



F04
Nero
Black



F03
Grigio polvere
Dust grey



F18
Grigio cenere
Ash gray

Cuoio - Hide



* Colori disponibili per collezione Guapa. - Available colors for Guapa collection.

Cuoio rigenerato - Regenerated hide

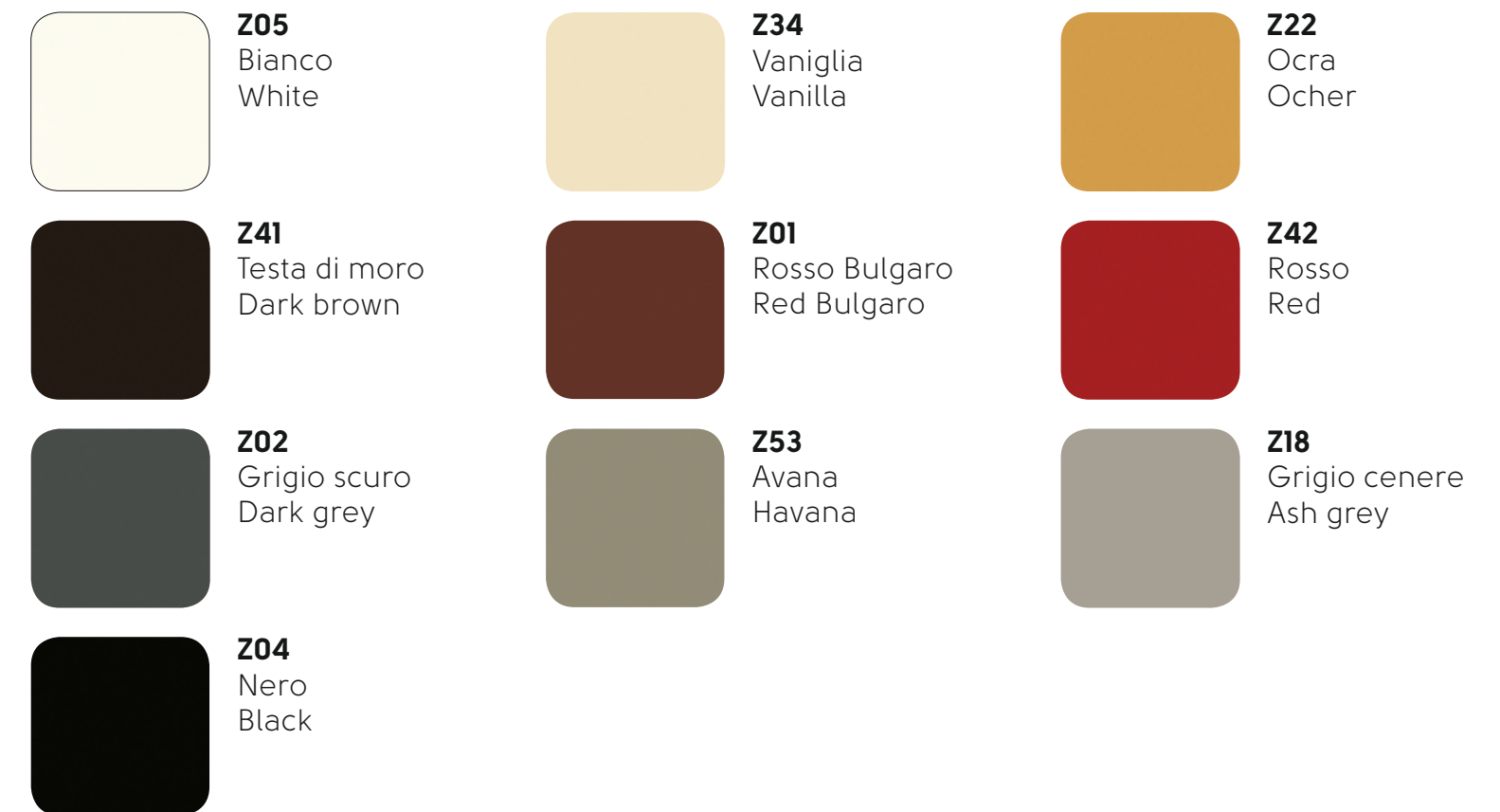

Rete - Mesh



Trapuntato - Quilted



710
Bianco
White



709
Catrame
Catrame



708
Cemento
Cemento

Elastico - Elastic



EL3
Perla
Perla



EL4
Nero
Black



EL7
Lilla
Liliac

Plastiche - Plastics

Polipropilene - Polypropylene

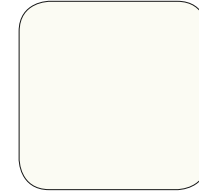

P05
Bianco
White



P07
Sabbia
Sand



P06
Grigio cielo
Sky grey

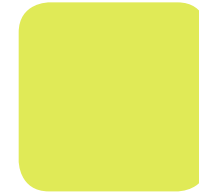

P18
Verde
Green



P27
Lilla
Liliac



P08
Rosso
Red



P04
Nero
Black

Hirek - Hirek

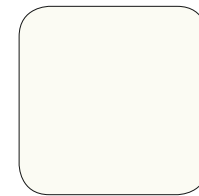

HR5
Bianco
White



HR7
Sabbia
Sand



HR8
Rosso
Red

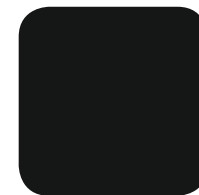

HR4
Nero
Black

Restylon - Restylon

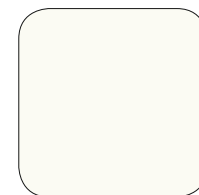

R05
Bianco
White



R07
Sabbia
Sand



R02
Fango
Fango



R06
Blu
Blue



R08
Rosso
Red

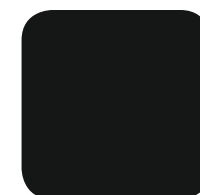

R04
Nero
Black

Policarbonato lucido - Glossy polycarbonate



H30
Trasparente
Transparent



Y05
Bianco
White



Y07
Sabbia
Sand



Y08
Rosso
Red



H08
Rosso
trasparente
Red
transparent



H21
Arancio
trasparente
Orange
transparent



H41
Fumè
trasparente
Fumè
transparent



Y04
Nero
Black

Legni - Wood

MDF laccato - Lacquered MDF

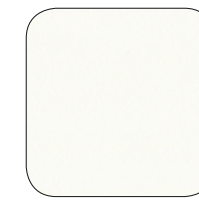

D05
Bianco
White



D07
Corda
Sand



D02
Grafite
Grafite



D41
Testa di moro
Dark brown

Melaminico - Melamine

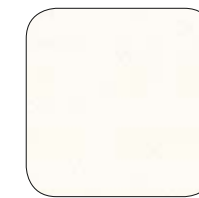

M01
Bianco
White



M07
Corda
Sand



M02
Grafite
Grafite



M14
Noce
Walnut



M12
Rok
Rok

Impiallacciato - Veneered wood



L40
Finitura rovere
naturale
Natural oak finish



L26
Finitura rovere
moro
Dark oak finish



L14
Finitura noce
Walnut veneer
finish

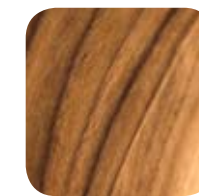

L24
Noce fiammato
Flamed walnut

Legno - Wood



LM1
Massello di noce
corteccia - Solid
walnut bark

Metalli - Metals



R
Alluminio
Aluminium

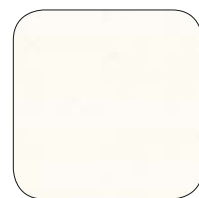

Y
Bianco
White



S
Corda
Sand



G
Grafite
Grafite



T
Testa di moro
Dark brown



MC
Multicolor
Multicolor



C
Cromo
Chrome

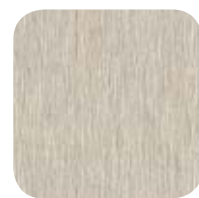

K
Satinato
Satin



D
Cenere
Ash Grey



F
Nero
Black



Z
Nichel nero
Black nickel



R
Oro rosa
Pink gold

Italian know-how

Se capacità industriale e tecnologie avanzate sono la nostra forza, la maestria nel fare è la nostra anima, ciò che davvero ci distingue. Il saper fare rappresenta il cuore della nostra azienda: grazie ad esso tutti i nostri progetti prendono vitalità e slancio, a partire da una vocazione artigiana che viene ininterrottamente coltivata e perfezionata.

If industrial capacity and advanced technology are our strength, the know-how skill is our soul, what really sets us apart.

The know-how is the heart of our company: thanks to it all our projects take vitality and outburst, from a handcrafted vocation that is continuously cultivated and perfected.



MIDJ srl
Via Madonna di Campagna, 2/A
33075 Cordovado (PN) - Italy
T +39.0434690122
www.midj.it
info@midj.it

Project:	Vassalli associati
Art direction:	Gianluca Vassalli
Graphic design:	Alessandro Orteschi
Stylist:	Barbara Marsiletti
Photo:	Salmaso fotografia
Color separation:	GM Studio 1
Print:	Grafiche Gemma

